

# Operation Manual

## Mode d'emploi

Multi-CD control High power CD/MP3/WMA player  
with FM/AM tuner

Syntoniseur FM/AM et lecteur de CD/MP3/WMA,  
"Puissance élevée", avec contrôleur pour lecteur de  
CD à chargeur

# DEH-P3700MP

English

Français

Español

**SUPER**  **TUNER III** 

## Thank you for buying this Pioneer product.

Please read through these operating instructions so you will know how to operate your model properly. *After you have finished reading the instructions, keep this manual in a safe place for future reference.*

### 01 Before You Start

- Information to User **4**
- For Canadian model **4**
- About this unit **4**
- About this manual **4**
- After-sales service for Pioneer products **5**
- Product registration **5**
- Features **5**
- About WMA **6**
- Use and care of the remote control **6**
  - Installing the battery **6**
  - Using the remote control **6**
- About the SAT RADIO READY mark **7**
- Protecting your unit from theft **7**
  - Removing the front panel **7**
  - Attaching the front panel **7**

### 02 What's What

- Head unit **8**
- Remote control **9**

### 03 Power ON/OFF

- Turning the unit on **10**
- Selecting a source **10**
- Turning the unit off **10**

### 04 Tuner

- Listening to the radio **11**
- Introduction of advanced tuner operation **12**
- Storing and recalling broadcast frequencies **12**
- Tuning in strong signals **12**
- Storing the strongest broadcast frequencies **13**

### 05 Built-in CD Player

- Playing a CD **14**

- Introduction of advanced built-in CD player operation **15**
- Repeating play **15**
- Playing tracks in a random order **15**
- Scanning tracks of a CD **15**
- Pausing CD playback **16**
- Using compression and BMX **16**
- Selecting the search method **16**
- Searching every 10 tracks in the current disc **17**
- Using disc title functions **17**
  - Entering disc titles **17**
  - Displaying disc titles **18**
- Using CD TEXT functions **18**
  - Displaying titles on CD TEXT discs **18**
  - Scrolling titles in the display **18**

### 06 MP3/WMA/WAV Player

- Playing MP3/WMA/WAV **19**
- Introduction of advanced built-in CD player (MP3/WMA/WAV) operation **20**
- Repeating play **20**
- Playing tracks in a random order **21**
- Scanning folders and tracks **21**
- Pausing MP3/WMA/WAV playback **22**
- Selecting the search method **22**
- Searching every 10 tracks in the current folder **22**
- Using compression and BMX **22**
- Displaying text information on MP3/WMA disc **23**
- Displaying text information on WAV disc **23**
- Scrolling text information in the display **23**

### 07 Multi-CD Player

- Playing a CD **24**
- 50-disc multi-CD player **24**

Introduction of advanced multi-CD player operation **25**

Repeating play **25**

Playing tracks in a random order **25**

Scanning CDs and tracks **26**

Pausing CD playback **26**

Using ITS playlists **26**

- Creating a playlist with ITS programming **26**
- Playback from your ITS playlist **27**
- Erasing a track from your ITS playlist **27**
- Erasing a CD from your ITS playlist **28**

Using disc title functions **28**

- Entering disc titles **28**
- Displaying disc titles **29**

Using CD TEXT functions **29**

- Displaying titles on CD TEXT discs **29**
- Scrolling titles in the display **29**

Using compression and bass emphasis **29**

## 08 Audio Adjustments

Introduction of audio adjustments **30**

Using balance adjustment **30**

Using the equalizer **30**

- Recalling equalizer curves **30**
- Adjusting equalizer curves **31**
- Fine-adjusting equalizer curve **31**

Adjusting loudness **32**

Front image enhancer (F.I.E.) **32**

Adjusting source levels **32**

## 09 Initial Settings

Adjusting initial settings **34**

Setting the clock **34**

Switching the auxiliary setting **34**

## 10 Other Functions

Turning the clock display on or off **35**

Using the AUX source **35**

- Selecting AUX as the source **35**
- Setting the AUX title **35**

Introduction of XM operation **36**

- XM operation **36**
- Switching the XM channel select setting **36**

## Additional Information

Understanding built-in CD player error messages **37**

CD player and care **37**

CD-R/CD-RW discs **38**

MP3, WMA and WAV files **38**

- MP3 additional information **39**
- WMA additional information **39**
- WAV additional information **39**

About folders and MP3/WMA/WAV files **40**

Terms **41**

Specifications **43**

## Information to User

Alteration or modifications carried out without appropriate authorization may invalidate the user's right to operate the equipment.



## For Canadian model

This Class B digital apparatus complies with Canadian ICES-003.



## About this unit

The tuner frequencies on this unit are allocated for use in North America. Use in other areas may result in poor reception.

### WARNING:

Handling the cord on this product or cords associated with accessories sold with the product will expose you to lead, a chemical known to the State of California and other governmental entities to cause cancer and birth defects or other reproductive harm. ***Wash hands after handling.***

**CAUTION:**  
**USE OF CONTROL OR ADJUSTMENT OR PERFORMANCE OF PROCEDURES OTHER THAN THOSE SPECIFIED HEREIN MAY RESULT IN HAZARDOUS RADIATION EXPOSURE.**

**CAUTION:**  
**THE USE OF OPTICAL INSTRUMENTS WITH THIS PRODUCT WILL INCREASE EYE HAZARD.**

### CAUTION

- Do not allow this unit to come into contact with liquids. Electrical shock could result. Also, this unit damage, smoke, and overheat could result from contact with liquids.
- Keep this manual handy as a reference for operating procedures and precautions.
- Always keep the volume low enough so that you can hear sounds from outside the vehicle.
- Protect this unit from moisture.
- If the battery is disconnected or discharged, the preset memory will be erased and must be reprogrammed.

### Important (Serial number)

The serial number is located on the bottom of this unit. For your own security and convenience, be sure to record this number on the enclosed warranty card. 

## About this manual

This unit features a number of sophisticated functions ensuring superior reception and operation. All the functions have been designed for the easiest possible use, but many are not self-explanatory. This operation manual will help you benefit fully from this unit's potential and to maximize your listening enjoyment. We recommend that you familiarize yourself with the functions and their operation by reading through the manual before you begin using this unit. It is especially important that you read and observe **WARNINGs** and **CAUTIONs** in this manual. 

## Before You Start

### After-sales service for Pioneer products

Please contact the dealer or distributor from where you purchased this unit for after-sales service (including warranty conditions) or any other information. In case the necessary information is not available, please contact the companies listed below:

Please do not ship your unit to the companies at the addresses listed below for repair without advance contact.

#### U.S.A.

Pioneer Electronics (USA) Inc.  
CUSTOMER SUPPORT DIVISION  
P.O. Box 1760  
Long Beach, CA 90801-1760  
800-421-1404

#### CANADA

Pioneer Electronics of Canada, Inc.  
CUSTOMER SATISFACTION DEPARTMENT  
300 Allstate Parkway  
Markham, Ontario L3R 0P2  
1-877-283-5901

For warranty information please see the Limited Warranty sheet included with this unit. 

### Product registration

Visit us at the following site:

  
<http://www.pioneerelectronics.com>

- 1 Register your product. We will keep the details of your purchase on file to help you refer to this information in the event of an insurance claim such as loss or theft.
- 2 Receive updates on the latest products and technologies.

- 3 Download owner's manuals, order product catalogues, research new products, and much more. 

### Features

#### CD playback

Music CD/CD-R/CD-RW playback is possible.

#### MP3 file playback

You can play back MP3 files recorded on CD-ROM/CD-R/CD-RW (ISO9660 Level 1/Level 2 standard recordings).

- Supply of this product only conveys a license for private, non-commercial use and does not convey a license nor imply any right to use this product in any commercial (i.e. revenue-generating) real time broadcasting (terrestrial, satellite, cable and/or any other media), broadcasting/streaming via internet, intranets and/or other networks or in other electronic content distribution systems, such as pay-audio or audio-on-demand applications. An independent license for such use is required. For details, please visit <http://www.mp3licensing.com>.

#### WMA file playback

You can play back WMA files recorded on CD-ROM/CD-R/CD-RW (ISO9660 Level 1/Level 2 standard recordings).

#### WAV file playback

You can play back WAV files recorded on CD-ROM/CD-R/CD-RW (Linear PCM (LPCM)/MS ADPCM recordings). 

## About WMA



The Windows Media™ logo printed on the box indicates that this unit can play back WMA data.

WMA is short for Windows Media™ Audio and refers to an audio compression technology that is developed by Microsoft Corporation. WMA data can be encoded by using Windows Media Player version 7 or later. Microsoft, Windows Media, and the Windows logo are trademarks, or registered trademarks of Microsoft Corporation in the United States and/or other countries.



### Notes

- With some applications used to encode WMA files, this unit may not operate correctly.
- Depending on the version of Windows Media Player used to encode WMA files, album names and other text information may not be correctly displayed.
- There may be a slight delay when starting playback of WMA files encoded with image data. ▣

## Use and care of the remote control

### Installing the battery

Slide the tray out on the back of the remote control and insert the battery with the plus (+) and minus (-) poles pointing in the proper direction.

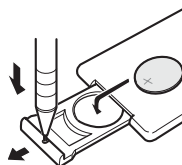

### WARNING

Keep the battery out of the reach of children. Should the battery be swallowed, immediately consult a doctor.



### CAUTION

- Use only one **CR2025 (3 V)** lithium battery.
- Remove the battery if the remote control is not used for a month or longer.
- Do not recharge, disassemble, heat or dispose of the battery in fire.
- Do not handle the battery with metallic tools.
- Do not store the battery with metallic materials.
- In the event of battery leakage, wipe the remote control completely clean and install a new battery.
- When disposing of used batteries, please comply with governmental regulations or environmental public institutions' rules that apply in your country/area.

### Using the remote control

Point the remote control in the direction of the front panel to operate.

## Before You Start

### Important

- Do not store the remote control in high temperatures or direct sunlight.
- The remote control may not function properly in direct sunlight.
- Do not let the remote control fall onto the floor, where it may become jammed under the brake or accelerator pedal. 

## About the SAT RADIO READY mark



The SAT RADIO READY mark printed on the front panel indicates that the Satellite Radio Tuner for Pioneer (aka, XM tuner and Sirius satellite tuner which are sold separately) can be controlled by this unit. Please inquire to your dealer or nearest authorized Pioneer service station regarding the satellite radio tuner that can be connected to this unit. For satellite radio tuner operation, please refer to the satellite radio tuner owner's manual.

### Notes

- The system will use direct satellite-to-receiver broadcasting technology to provide listeners in their cars and at home with crystal-clear sound seamlessly from coast to coast. Satellite radio will create and package over 100 channels of digital-quality music, news, sports, talk and children's programming.
- "SAT Radio", the SAT Radio logo and all related marks are trademarks of Sirius Satellite Radio inc., and XM Satellite Radio Inc. 

## Protecting your unit from theft

The front panel can be detached from the head unit to discourage theft.

### Important

- Never use force or grip the display and the buttons too tightly when removing or attaching.
- Avoid subjecting the front panel to excessive shocks.
- Keep the front panel out of direct sunlight and high temperatures.

## Removing the front panel

### 1 Press DETACH to release the front panel.

Press **DETACH** and the right side of the panel is released from the head unit.

### 2 Grab the front panel and remove.

Grab the right side of the front panel and pull away to the left. The front panel will be detached from the head unit.

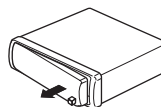

## Attaching the front panel

### 1 Place the front panel flat against the head unit.

### 2 Press the front panel into the face of the head unit until it is firmly seated.

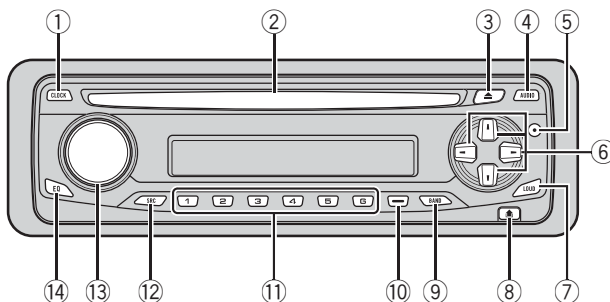

## Head unit

- ① **CLOCK button**  
Press to change to the clock display.
- ② **Disc loading slot**  
Insert a disc to play.
- ③ **EJECT button**  
Press to eject a CD from your built-in CD player.
- ④ **AUDIO button**  
Press to select various sound quality controls.
- ⑤ **FUNCTION button**  
Press to select functions.
- ⑥ **▲/▼/◀/▶ buttons**  
Press to do manual seek tuning, fast forward, reverse and track search controls. Also used for controlling functions.
- ⑦ **LOUDNESS button**  
Press to turn loudness on or off.
- ⑧ **DETACH button**  
Press to remove the front panel from the head unit.
- ⑨ **BAND button**  
Press to select among three FM bands and one AM band and to cancel the control mode of functions.
- ⑩ **DISPLAY button**  
Press to select different displays.
- ⑪ **1–6 buttons**  
Press for preset tuning and disc number search when using a multi-CD player.
- ⑫ **SOURCE button**  
This unit is turned on by selecting a source. Press to cycle through all the available sources.
- ⑬ **VOLUME**  
Rotate it to increase or decrease the volume.
- ⑭ **EQ button**  
Press to select various equalizer curves. 



## What's What

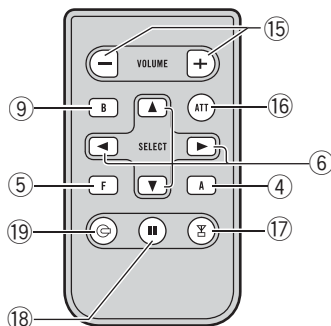

## Remote control

Operation is the same as when using the buttons on the head unit. See the explanation of the head unit about the operation of each button with the exception of **ATT**, which is explained below.

### ⑮ VOLUME (+/-) buttons

Press to increase or decrease the volume.

### ⑯ ATT button

Press to quickly lower the volume level, by about 90%. Press once more to return to the original volume level.

### ⑰ TUNER button

Press to select the tuner as the source.

### ⑱ PAUSE button

Press to turn pause on or off.

### ⑲ CD button

Press to select the built-in or multi-CD player as the source.

## Turning the unit on

- **Press SOURCE to turn the unit on.**

When you select a source the unit is turned on. 

## Selecting a source

You can select a source you want to listen to. To switch to the built-in CD player, load a disc in the unit (refer to page 14).

- **Press SOURCE to select a source.**

Press **SOURCE** repeatedly to switch between the following sources:

**Built-in CD player—Television—Tuner—XM tuner—Multi-CD player—External unit 1—External unit 2—AUX**

- **When using the remote control, press TUNER or CD to select a source.**

Press each button repeatedly to switch between the following sources:

**TUNER: Television—Tuner—XM tuner—Sources off**

**CD: Built-in CD player—Multi-CD player—Sources off**



### Notes

- In the following cases, the sound source will not change:
  - When there is no unit corresponding to the selected source connected to this unit.
  - When there is no disc in the unit.
  - When there is no magazine in the multi-CD player.
  - When the AUX (auxiliary input) is set to off (refer to page 34).
- External unit refers to a Pioneer product (such as one available in the future) that, although incompatible as a source, enables control of basic functions by this unit. Two external units can be controlled by this unit. When two exter-

nal units are connected, the allocation of them to external unit 1 or external unit 2 is automatically set by this unit.

- When this unit's blue/white lead is connected to the vehicle's auto-antenna relay control terminal, the vehicle's antenna extends when this unit's source is turned on. To retract the antenna, turn the source off. 

## Turning the unit off

- **Press SOURCE and hold until the unit turns off.** 

# Tuner

## Listening to the radio

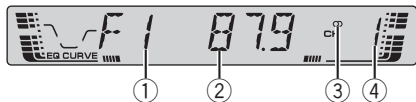

These are the basic steps necessary to operate the radio. More advanced tuner operation is explained starting on the next page.

### ① Band indicator

Shows which band the radio is tuned to, AM or FM.

### ② Frequency indicator

Shows to which frequency the tuner is tuned.

### ③ Stereo (Ⓞ) indicator

Shows that the frequency selected is being broadcast in stereo.

### ④ Preset number indicator

Shows which preset has been selected.

## 1 Press SOURCE to select the tuner.

Press **SOURCE** until tuner is selected as the source.

## 2 Use VOLUME to adjust the sound level.

Rotate it to increase or decrease the volume.

## 3 Press BAND to select a band.

Press **BAND** until the desired band is displayed, **F1**, **F2**, **F3** for FM or **AM**.

## 4 To perform manual tuning, briefly press

◀ or ▶.

The frequencies move up or down step by step.

## 5 To perform seek tuning, press and hold

◀ or ▶ for about one second and release. The tuner will scan the frequencies until a broadcast strong enough for good reception is found.

- You can cancel seek tuning by briefly pressing either ◀ or ▶.
- If you press and hold ◀ or ▶ you can skip stations. Seek tuning starts as soon as you release the button.



### Note

When the frequency selected is being broadcast in stereo the stereo (Ⓞ) indicator will light. ■

## Introduction of advanced tuner operation

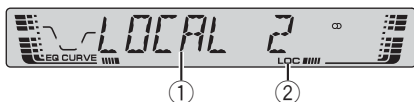

### ① Function display

Shows the function status.

### ② LOC indicator

Shows when local seek tuning is on.

### ● Press FUNCTION to display the function names.

Press **FUNCTION** repeatedly to switch between the following functions:

**BSM** (best stations memory)—**LOCAL** (local seek tuning)

- To return to the frequency display, press **BAND**.

### Note

If you do not operate the function within about 30 seconds, the display is automatically returned to the frequency display. 

## Storing and recalling broadcast frequencies

If you press any of the preset tuning buttons **1–6** you can easily store up to six broadcast frequencies for later recall with the touch of a button.

### ● When you find a frequency that you want to store in memory press one of preset tuning buttons **1–6** and hold until the preset number stops flashing.

The number you have pressed will flash in the preset number indicator and then remain lit. The selected radio station frequency has been stored in memory.

The next time you press the same preset tuning button the radio station frequency is recalled from memory.

### Notes

- Up to 18 FM stations, six for each of the three FM bands, and six AM stations can be stored in memory.
- You can also use **▲** and **▼** to recall radio station frequencies assigned to preset tuning buttons **1–6**. 

## Tuning in strong signals

Local seek tuning lets you tune in only those radio stations with sufficiently strong signals for good reception.

### 1 Press FUNCTION to select LOCAL.

Press **FUNCTION** until **LOCAL** appears in the display.

### 2 Press ▲ to turn local seek tuning on.

Local seek sensitivity (e.g., **LOCAL 2**) appears in the display.

### 3 Press ◀ or ▶ to set the sensitivity.

There are four levels of sensitivity for FM and two levels for AM:

FM: **LOCAL 1—LOCAL 2—LOCAL 3—**

**LOCAL 4**

AM: **LOCAL 1—LOCAL 2**

The **LOCAL 4** setting allows reception of only the strongest stations, while lower settings let you receive progressively weaker stations.

**4 When you want to return to normal seek tuning, press ▼ to turn local seek tuning off.**

**LOCAL.OFF** appears in the display. 

## Storing the strongest broadcast frequencies

BSM (best stations memory) lets you automatically store the six strongest broadcast frequencies under preset tuning buttons **1–6** and once stored there you can tune in to those frequencies with the touch of a button.

**1 Press FUNCTION to select BSM.**

Press **FUNCTION** until **BSM** appears in the display.

**2 Press ▲ to turn BSM on.**

**BSM** begins to flash. While **BSM** is flashing the six strongest broadcast frequencies will be stored under preset tuning buttons **1–6** in the order of their signal strength. When finished, **BSM** stops flashing.

- To cancel the storage process, press ▼.



### Note

Storing broadcast frequencies with BSM may replace broadcast frequencies you have saved using buttons **1–6**. 

## Playing a CD



These are the basic steps necessary to play a CD with your built-in CD player. More advanced CD operation is explained starting on the next page.

### ① Play time indicator

Shows the elapsed playing time of the current track.

### ② Track number indicator

Shows the track currently playing.

### 1 Insert a CD into the CD loading slot.

Playback will automatically start.

- **Be sure to turn up the label side of a disc.**
- After a CD has been inserted, press **SOURCE** to select the built-in CD player.
- You can eject a CD by pressing **EJECT**.

### 2 Use **VOLUME** to adjust the sound level.

Rotate it to increase or decrease the volume.

### 3 To perform fast forward or reverse, press and hold ◀ or ▶.

- If you select **ROUGH**, pressing and holding ◀ or ▶ enables you to search every 10 tracks in the current disc. (Refer to *Selecting the search method* on page 16.)

### 4 To skip back or forward to another track, press ◀ or ▶.

Pressing ▶ skips to the start of the next track. Pressing ◀ once skips to the start of the current track. Pressing again will skip to the previous track.

## Notes

- The built-in CD player plays one, standard, 12-cm or 8-cm (single) CD at a time. Do not use an adapter when playing 8-cm CDs.
- Do not insert anything other than a CD into the CD loading slot.
- If you cannot insert a disc completely or if after you insert a disc the disc does not play, check that the label side of the disc is up. Press **EJECT** to eject the disc, and check the disc for damage before inserting it again.
- If an error message such as **ERROR-11** is displayed, refer to *Understanding built-in CD player error messages* on page 37.
- When a CD TEXT disc is inserted, the disc and track titles begin to scroll to the left automatically. 

## Built-in CD Player

### Introduction of advanced built-in CD player operation

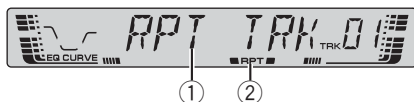

#### ① Function display

Shows the function status.

#### ② RPT indicator

Shows when repeat play is turned on.

#### ● Press FUNCTION to display the function names.

Press **FUNCTION** repeatedly to switch between the following functions:

**RPT** (repeat play)—**RDM** (random play)

—**SCAN** (scan play)—**PAUSE** (pause)—**COMP** (compression and BMX)—**FF/REV** (search method)

- To return to the playback display, press **BAND**.



#### Note

If you do not operate the function within about 30 seconds, the display is automatically returned to the playback display.

### Repeating play

Repeat play lets you hear the same track over again.

#### 1 Press FUNCTION to select RPT.

Press **FUNCTION** until **RPT** appears in the display.

#### 2 Press ◀ or ▶ to select the repeat range.

This switches you to the selected setting.

- **DSC** – Repeat the current disc

- **TRK** – Repeat just the current track



#### Note

If you perform track search or fast forward/reverse during **TRK**, the repeat play range changes to **DSC**.

### Playing tracks in a random order

Random play lets you play back tracks on the CD in a random order.

#### 1 Press FUNCTION to select RDM.

Press **FUNCTION** until **RDM** appears in the display.

#### 2 Press ▲ to turn random play on.

**RDM ON** appears in the display. Tracks will play in a random order.

#### 3 Press ▼ to turn random play off.

**RDM OFF** appears in the display. Tracks will continue to play in order.

### Scanning tracks of a CD

Scan play lets you hear the first 10 seconds of each track on the CD.

#### 1 Press FUNCTION to select SCAN.

Press **FUNCTION** until **SCAN** appears in the display.

#### 2 Press ▲ to turn scan play on.

**SCAN ON** appears in the display. The first 10 seconds of each track is played.

## Built-in CD Player

### 3 When you find the desired track press ▼ to turn scan play off.

**SCAN OFF** appears in the display. The track will continue to play.

- If the display has automatically returned to the playback display, select **SCAN** again by pressing **FUNCTION**.

#### Note

After scanning of a CD is finished, normal playback of the tracks will begin again. 

## Pausing CD playback

Pause lets you temporarily stop playback of the CD.

### 1 Press **FUNCTION** to select **PAUSE**.

Press **FUNCTION** until **PAUSE** appears in the display.

### 2 Press ▲ to turn pause on.

**PAUSE.ON** appears in the display. Play of the current track pauses.

### 3 Press ▼ to turn pause off.

**PAUSE.OFF** appears in the display. Play will resume at the same point that you turned pause on.

#### Note

You can also turn pause on or off by pressing **PAUSE**. 

## Using compression and BMX

Using the **COMP** (compression) and **BMX** functions let you adjust the sound playback quality of this player. Each of the functions have a two-step adjustment. The **COMP** func-

tion balances the output of louder and softer sounds at higher volumes. **BMX** controls sound reverberations to give playback a fuller sound. Listen to each of the effects as you select through them and use the one that best enhances the playback of the track or CD that you are listening to.

### 1 Press **FUNCTION** to select **COMP**.

Press **FUNCTION** until **COMP** appears in the display.

### 2 Press ▲ or ▼ to select your favorite setting.

Press ▲ or ▼ repeatedly to switch between the following settings:

**COMP OFF—COMP 1—COMP 2—  
COMP OFF—BMX 1—BMX 2** 

## Selecting the search method

You can switch the search method between fast forward/reverse and searching every 10 tracks.

### 1 Press **FUNCTION** to select **FF/REV**.

Press **FUNCTION** until **FF/REV** appears in the display.

- If the search method **ROUGH** has been previously selected, **ROUGH** will be displayed.

### 2 Press ◀ or ▶ to select the search method.

Press ◀ or ▶ until the desired search method appears in the display.

- **FF/REV** – Fast forward and reverse
- **ROUGH** – Searching every 10 tracks 



## Built-in CD Player

### Searching every 10 tracks in the current disc

If a disc contains over 10 tracks, you can search every 10 tracks. When a disc contains a lot of tracks, you can roughly search for the track you want to play.

#### 1 Select the search method **ROUGH**.

Refer to *Selecting the search method* on the previous page.

#### 2 Press and hold ◀ or ▶ to search every 10 tracks on a disc.

- If a disc contains less than 10 tracks, pressing and holding ▶ recalls the last track of the disc.

Also, if the remaining number of tracks after searching every 10 tracks is less than 10, pressing and holding ▶ recalls the last track of the disc.

- If a disc contains less than 10 tracks, pressing and holding ◀ recalls the first track of the disc.

Also, if the remaining number of tracks after searching every 10 tracks is less than 10, pressing and holding ◀ recalls the first track of the disc. □

### Using disc title functions

You can input CD titles and display the title. The next time you insert a CD for which you have entered a title, the title of that CD will be displayed.

#### Entering disc titles

Use the disc title input feature to store up to 48 CD titles in the unit. Each title can be up to 8 characters long.

#### 1 Play the CD that you want to enter a title for.

#### 2 Press **FUNCTION** and hold until **TITLE IN** appears in the display.

- When playing a CD **TEXT** disc, you cannot switch to **TITLE IN**. The disc title will have already been recorded on a CD **TEXT** disc.

#### 3 Press ▲ or ▼ to select a letter of the alphabet.

Each press of ▲ will display a letter of the alphabet in **A B C ... X Y Z**, numbers and symbols in **1 2 3 ... > [ ]** order. Each press of ▼ will display a letter in the reverse order, such as **Z Y X ... C B A** order.

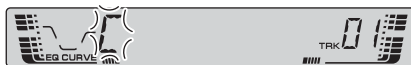

#### 4 Press ▶ to move the cursor to the next character position.

When the letter you want is displayed, press ▶ to move the cursor to the next position and then select the next letter. Press ◀ to move backwards in the display.

#### 5 Move the cursor to the last position by pressing ▶ after entering the title.

When you press ▶ one more time, the entered title is stored in memory.

#### 6 Press **BAND** to return to the playback display.



#### Notes

- Titles remain in memory, even after the disc has been removed from the unit, and are recalled when the disc is reinserted.
- After data for 48 discs has been stored in memory, data for a new disc will overwrite the oldest one.
- If you connect a multi-CD player, you can input disc titles for up to 100 discs.

## Displaying disc titles

You can display the title of any disc that has had a disc title entered.

- **Press DISPLAY.**

Press **DISPLAY** repeatedly to switch between the following settings:

Play time—**DISC TTL** (disc title)

When you select **DISC TTL**, the title of the currently playing disc is shown in the display.

- If no title has been entered for the currently playing disc, **NO TITLE** is displayed. 

- **Press DISPLAY and hold until the title begins to scroll to the left.**

The rest of the title will appear in the display. 

## Using CD TEXT functions

Some discs have certain information encoded on the disc during manufacture. These discs may contain such information as the CD title, track title, artist's name and playback time and are called CD TEXT discs. Only these specially encoded CD TEXT discs support the functions listed below.

### Displaying titles on CD TEXT discs

- **Press DISPLAY.**

Press **DISPLAY** repeatedly to switch between the following settings:

Play time—**DISC TTL** (disc title)—**ART NAME**

(disc artist name)—**TRK TTL** (track title)

—**ART NAME** (track artist name)

- If specific information has not been recorded on a CD TEXT disc, **NO XXXX** will be displayed (e.g., **NO D-TTL**).

### Scrolling titles in the display

This unit can display the first 8 letters only of **DISC TTL**, **ART NAME**, **TRK TTL** and **ART NAME**. When the recorded information is longer than 8 letters, you can scroll the text to the left so that the rest of the title can be seen.

# MP3/WMA/WAV Player

## Playing MP3/WMA/WAV

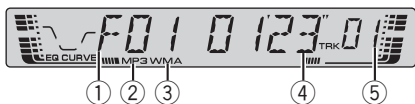

These are the basic steps necessary to play an MP3/WMA/WAV with your built-in CD player. More advanced MP3/WMA/WAV operation is explained starting on the next page.

### ① Folder number indicator

Shows the number of folder currently playing.

### ② MP3 indicator

Shows when the MP3 file is playing.

### ③ WMA indicator

Shows when the WMA file is playing.

### ④ Play time indicator

Shows the elapsed playing time of the current track (file).

### ⑤ Track number indicator

Shows the track (file) currently playing.

- If a track number 100 to 199 is selected, ► on the left of the track number indicator will light.
- If a track number 200 or more is selected, ► on the left of the track number indicator will blink.

## 1 Insert a CD-ROM into the CD loading slot.

Playback will automatically start.

- **Be sure to turn up the label side of a disc.**
- After a CD-ROM has been inserted, press **SOURCE** to select the built-in CD player.
- You can eject a CD-ROM by pressing **EJECT**.

**2 Use VOLUME to adjust the sound level.**  
Rotate it to increase or decrease the volume.

### 3 Press ▲ or ▼ to select a folder.

- You cannot select a folder that does not have an MP3/WMA/WAV file recorded in it.
- To return to folder 01 (ROOT), press and hold **BAND**. However, if folder 01 (ROOT) contains no files, playback commences with folder 02.

### 4 To perform fast forward or reverse, press and hold ◀ or ▶.

- This is fast forward and reverse operation only for the file being played. This operation is canceled when the previous or next file is reached.
- If you select **ROUGH**, pressing and holding ◀ or ▶ enables you to search every 10 tracks in the current folder. (Refer to *Selecting the search method* on page 22.)

### 5 To skip back or forward to another track, press ◀ or ▶.

Pressing ▶ skips to the start of the next track. Pressing ◀ once skips to the start of the current track. Pressing again will skip to the previous track.



### Notes

- When playing discs with MP3/WMA/WAV files and audio data (CD-DA) such as CD-EXTRA and MIXED-MODE CDs, both types can be played only by switching mode between MP3/WMA/WAV and CD-DA with **BAND**.
- If you have switched between playback of MP3/WMA/WAV files and audio data (CD-DA), playback starts at the first track on the disc.
- The built-in CD player can play back an MP3/WMA/WAV file recorded on CD-ROM. (Refer to page 38 for files that can be played back.)
- Do not insert anything other than a CD into the CD loading slot.
- There is sometimes a delay between starting up CD playback and the sound being issued. When being read in, **FRMTREAD** is displayed.

- If you cannot insert a disc completely or if after you insert a disc the disc does not play, check that the label side of the disc is up. Press **EJECT** to eject the disc, and check the disc for damage before inserting it again.
- Playback is carried out in order of file number. Folders are skipped if they contain no files. (If folder 01 (ROOT) contains no files, playback commences with folder 02.)
- When playing back files recorded as VBR (variable bit rate) files, the play time will not be correctly displayed if fast forward or reverse operations are used.
- There is no sound on fast forward or reverse.
- If an error message such as **ERROR-11** is displayed, refer to *Understanding built-in CD player error messages* on page 37.
- When an MP3/WMA/WAV disc is inserted, folder name and file name begin to scroll to the left automatically. 

## Introduction of advanced built-in CD player (MP3/WMA/WAV) operation

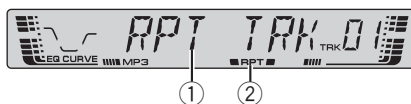

- ① **Function display**  
Shows the function status.
- ② **RPT indicator**  
Shows when repeat range is selected to current track (file).

### ● Press **FUNCTION** to display the function names.

Press **FUNCTION** repeatedly to switch between the following functions:

**RPT** (repeat play)—**RDM** (random play)  
—**SCAN** (scan play)—**PAUSE** (pause)—**COMP** (compression and BMX)—**FF/REV** (search method)

- To return to the playback display, press **BAND**.



### Note

If you do not operate the function within about 30 seconds, the display is automatically returned to the playback display. 

## Repeating play

For MP3/WMA/WAV playback, there are three repeat play ranges: **FLD** (folder repeat), **TRK** (one-track repeat) and **DSC** (repeat all tracks).

### 1 Press **FUNCTION** to select **RPT**.

Press **FUNCTION** until **RPT** appears in the display.

## MP3/WMA/WAV Player

### 2 Press ◀ or ▶ to select the repeat range.

Press ◀ or ▶ until the desired repeat range appears in the display.

- **FLD** – Repeat the current folder
- **TRK** – Repeat just the current track
- **DSC** – Repeat all tracks

### Notes

- If you select another folder during repeat play, the repeat play range changes to **DSC**.
- If you perform track search or fast forward/reverse during **TRK**, the repeat play range changes to **FLD**.
- When **FLD** is selected, it is not possible to play back a subfolder of that folder. 

## Playing tracks in a random order

Random play lets you play back tracks in a random order within the repeat range, **FLD** and **DSC**.

### 1 Select the repeat range.

Refer to *Repeating play* on the previous page.

### 2 Press FUNCTION to select RDM.

Press **FUNCTION** until **RDM** appears in the display.

### 3 Press ▲ to turn random play on.

**RDM ON** appears in the display. Tracks will play in a random order within the previously selected **FLD** or **DSC** ranges.

### 4 Press ▼ to turn random play off.

**RDM OFF** appears in the display. Tracks will continue to play in order.

### Note

If you turn random play on during **FLD** and then return to the playback display, **FRDM** appears in the display. 

## Scanning folders and tracks

While you are using **FLD**, the beginning of each track in the selected folder plays for about 10 seconds. When you are using **DSC**, the beginning of the first track of each folder is played for about 10 seconds.

### 1 Select the repeat range.

Refer to *Repeating play* on the previous page.

### 2 Press FUNCTION to select SCAN.

Press **FUNCTION** until **SCAN** appears in the display.

### 3 Press ▲ to turn scan play on.

**SCAN ON** appears in the display. The first 10 seconds of each track of the current folder (or the first track of each folder) is played.

### 4 When you find the desired track (or folder) press ▼ to turn scan play off.

**SCAN OFF** appears in the display. The track (or folder) will continue to play.

- If the display has automatically returned to the playback display, select **SCAN** again by pressing **FUNCTION**.

### Notes

- After track or folder scanning is finished, normal playback of the tracks will begin again.
- If you turn scan play on during **FLD** and then return to the playback display, **FSCN** appears in the display. 

## Pausing MP3/WMA/WAV playback

Pause lets you temporarily stop playback of the MP3/WMA/WAV.

### 1 Press **FUNCTION** to select **PAUSE**.

Press **FUNCTION** until **PAUSE** appears in the display.

### 2 Press **▲** to turn pause on.

**PAUSE.ON** appears in the display. Play of the current track pauses.

### 3 Press **▼** to turn pause off.

**PAUSE.OFF** appears in the display. Play will resume at the same point that you turned pause on.



#### Note

You can also turn pause on or off by pressing **PAUSE**. 

## Selecting the search method

You can switch the search method between fast forward/reverse and searching every 10 tracks.

### 1 Press **FUNCTION** to select **FF/REV**.

Press **FUNCTION** until **FF/REV** appears in the display.

- If the search method **ROUGH** has been previously selected, **ROUGH** will be displayed.

### 2 Press **◀** or **▶** to select the search method.

Press **◀** or **▶** until the desired search method appears in the display.

- **FF/REV** – Fast forward and reverse
- **ROUGH** – Searching every 10 tracks 

## Searching every 10 tracks in the current folder

If the current folder contains over 10 tracks, you can search every 10 tracks. When one folder contains a lot of tracks, you can roughly search for the track you want to play.

### 1 Select the search method **ROUGH**.

Refer to *Selecting the search method* on this page.

### 2 Press and hold **◀** or **▶** to search every 10 tracks in the current folder.

- If the current folder contains less than 10 tracks, pressing and holding **▶** recalls the last track of the folder. Also, if the remaining number of tracks after searching every 10 tracks is less than 10, pressing and holding **▶** recalls the last track of the folder.
- If the current folder contains less than 10 tracks, pressing and holding **◀** recalls the first track of the folder. Also, if the remaining number of tracks after searching every 10 tracks is less than 10, pressing and holding **◀** recalls the first track of the folder. 

## Using compression and BMX

Using the **COMP** (compression) and **BMX** functions let you adjust the sound playback quality of this player. Each of the functions have a two-step adjustment. The **COMP** function balances the output of louder and softer sounds at higher volumes. **BMX** controls sound reverberations to give playback a fuller sound. Listen to each of the effects as you select through them and use the one that best enhances the playback of the track or CD that you are listening to.

## MP3/WMA/WAV Player

### 1 Press **FUNCTION** to select **COMP**.

Press **FUNCTION** until **COMP** appears in the display.

### 2 Press **▲** or **▼** to select your favorite setting.

Press **▲** or **▼** repeatedly to switch between the following settings:

**COMP OFF—COMP 1—COMP 2—  
COMP OFF—BMX 1—BMX 2** 

## Displaying text information on MP3/WMA disc

Text information recorded on a MP3/WMA disc can be displayed.

### ● Press **DISPLAY**.

Press **DISPLAY** repeatedly to switch between the following settings:

Play time—**FOLDER** (folder name)—**FILE** (file name)—**TRK TTL** (track title)—**ART NAME** (artist name)—**ALBM TTL** (album title)—**COMMENT** (comment)—Bit rate

- When playing back MP3 files recorded as VBR (variable bit rate) files, the bit rate value is not displayed even after switching to bit rate.

- When playing back WMA files recorded as VBR files, the average bit rate is displayed.

- When you have turned tag display off, you cannot switch to **TRK TTL**, **ART NAME**,

**ALBM TTL** or **COMMENT**.

- If specific information has not been recorded on an MP3/WMA disc, **NO XXXX** will be displayed (e.g., **NO NAME**).

- Depending on the version of iTunes® used to encode MP3 files, comment information may not be correctly displayed.

- iTunes® is a trademark of Apple Computer, Inc., registered in the U.S. and other countries.

- Depending on the version of Windows Media Player used to encode WMA files, album names

and other text information may not be correctly displayed. 

## Displaying text information on WAV disc

You can display text information recorded on a WAV disc.

### ● Press **DISPLAY**.

Press **DISPLAY** repeatedly to switch between the following settings:

Play time—**FOLDER** (folder name)—**FILE** (file name)—Sampling frequency

- Sampling frequency may not display all digits (e.g. **22.0 KHZ** is displayed when the sampling frequency is 22.05 kHz). 

## Scrolling text information in the display

This unit can display the first 8 letters only of **FOLDER**, **FILE**, **TRK TTL**, **ART NAME**, **ALBM TTL** and **COMMENT**. When the recorded information is longer than 8 letters, you can scroll the text to the left so that the rest of the text information can be seen.

### ● Press **DISPLAY** and hold until the text information begins to scroll to the left.

The rest of the text information will appear in the display. 

## Playing a CD



You can use this unit to control a multi-CD player, which is sold separately.

These are the basic steps necessary to play a CD with your multi-CD player. More advanced CD operation is explained starting on the next page.

### ① Disc number indicator

Shows the disc currently playing.

### ② Play time indicator

Shows the elapsed playing time of the current track.

### ③ Track number indicator

Shows the track currently playing.

## 1 Press SOURCE to select the multi-CD player.

Press **SOURCE** until multi-CD is selected as the source.

## 2 Use VOLUME to adjust the sound level.

Rotate it to increase or decrease the volume.

## 3 Select a disc you want to listen to with the 1–6 buttons.

For discs located at 1 to 6, press the corresponding button number.

If you want to select a disc located at 7 to 12, press and hold the corresponding numbers, such as **1** for disc 7, until the disc number appears in the display.

- You can also sequentially select a disc by pressing **▲/▼**.

**4 To perform fast forward or reverse, press and hold ◀ or ▶.**

**5 To skip back or forward to another track, press ◀ or ▶.**

Pressing **▶** skips to the start of the next track. Pressing **◀** once skips to the start of the current track. Pressing again will skip to the previous track.



### Notes

- When the multi-CD player performs the preparatory operations, **READY** is displayed.
- If an error message such as **ERROR-11** is displayed, refer to the multi-CD player owner's manual.
- If there are no discs in the multi-CD player magazine, **NO DISC** is displayed.
- When you select a CD TEXT disc on a CD TEXT compatible multi-CD player, the disc and track titles begin to scroll to the left automatically.

## 50-disc multi-CD player

Only those functions described in this manual are supported for 50-disc multi-CD players.



## Multi-CD Player

### Introduction of advanced multi-CD player operation

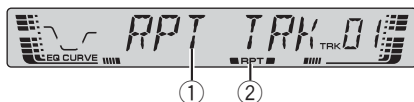

#### ① Function display

Shows the function status.

#### ② RPT indicator

Shows when repeat range is selected to current track.

#### ● Press FUNCTION to display the function names.

Press **FUNCTION** repeatedly to switch between the following functions:

**RPT** (repeat play)—**RDM** (random play)  
—**SCAN** (scan play)—**ITS-P** (ITS play)—**PAUSE** (pause)—**COMP** (compression and DBE)

- To return to the playback display, press **BAND**.

#### Note

If you do not operate the function within about 30 seconds, the display is automatically returned to the playback display. 

### Repeating play

There are three repeat play ranges for the multi-CD player: **MCD** (multi-CD player repeat), **TRK** (one-track repeat) and **DSC** (disc repeat).

#### 1 Press FUNCTION to select RPT.

Press **FUNCTION** until **RPT** appears in the display.

#### 2 Press ◀ or ▶ to select the repeat range.

Press ◀ or ▶ until the desired repeat range appears in the display.

- **MCD** – Repeat all discs in the multi-CD player
- **TRK** – Repeat just the current track
- **DSC** – Repeat the current disc



#### Notes

- If you select other discs during repeat play, the repeat play range changes to **MCD**.
- If you perform track search or fast forward/reverse during **TRK**, the repeat play range changes to **DSC**. 

### Playing tracks in a random order

Random play lets you play back tracks in a random order within the repeat range, **MCD** and **DSC**.

#### 1 Select the repeat range.

Refer to *Repeating play* on this page.

#### 2 Press FUNCTION to select RDM.

Press **FUNCTION** until **RDM** appears in the display.

#### 3 Press ▲ to turn random play on.

**RDM ON** appears in the display. Tracks will play in a random order within the previously selected **MCD** or **DSC** ranges.

#### 4 Press ▼ to turn random play off.

**RDM OFF** appears in the display. Tracks will continue to play in order.

**Note**

If you turn random play on during **DSC** and then return to the playback display, **DRDM** appears in the display.

## Scanning CDs and tracks

While you are using **DSC**, the beginning of each track on the selected disc plays for about 10 seconds. When you are using **MCD**, the beginning of the first track of each disc is played for about 10 seconds.

### 1 Select the repeat range.

Refer to *Repeating play* on the previous page.

### 2 Press **FUNCTION** to select **SCAN**.

Press **FUNCTION** until **SCAN** appears in the display.

### 3 Press **▲** to turn scan play on.

**SCAN ON** appears in the display. The first 10 seconds of each track of the current disc (or the first track of each disc) is played.

### 4 When you find the desired track (or disc) press **▼** to turn scan play off.

**SCAN OFF** appears in the display. The track (or disc) will continue to play.

- If the display has automatically returned to the playback display, select **SCAN** again by pressing **FUNCTION**.

**Notes**

- After track or disc scanning is finished, normal playback of the tracks will begin again.
- If you turn scan play on during **DSC** and then return to the playback display, **DSCN** appears in the display.

## Pausing CD playback

Pause lets you temporarily stop playback of the CD.

### 1 Press **FUNCTION** to select **PAUSE**.

Press **FUNCTION** until **PAUSE** appears in the display.

### 2 Press **▲** to turn pause on.

**PAUSE.ON** appears in the display. Play of the current track pauses.

### 3 Press **▼** to turn pause off.

**PAUSE.OFF** appears in the display. Play will resume at the same point that you turned pause on.

**Note**

You can also turn pause on or off by pressing **PAUSE**.

## Using ITS playlists

ITS (instant track selection) lets you make a playlist of favorite tracks from those in the multi-CD player magazine. After you have added your favorite tracks to the playlist you can turn on ITS play and play just those selections.

## Creating a playlist with ITS programming

You can use ITS to enter and play back up to 99 tracks per disc, up to 100 discs (with the disc titles). (With multi-CD players sold before the CDX-P1250 and CDX-P650, up to 24 tracks can be stored in the playlist.)

### 1 Play a CD that you want to program.

Press **▲** or **▼** to select the CD.

## Multi-CD Player

### 2 Press **FUNCTION** and hold until **TITLE IN** appears in the display, then press **FUNCTION** to select ITS.

After **TITLE IN** is displayed, press **FUNCTION** repeatedly, the following functions appear in the display:

**TITLE IN** (disc title input)—**ITS** (ITS programming)

### 3 Select the desired track by pressing ◀ or ▶.

### 4 Press ▲ to store the currently playing track in the playlist.

**ITS IN** is displayed briefly and the currently playing selection is added to your playlist. The display then shows **ITS** again.

### 5 Press **BAND** to return to the playback display.



#### Note

After data for 100 discs has been stored in memory, data for a new disc will overwrite the oldest one.

## Playback from your ITS playlist

ITS play lets you listen to the tracks that you have entered into your ITS playlist. When you turn on ITS play, tracks from your ITS playlist in the multi-CD player will begin to play.

### 1 Select the repeat range.

Refer to *Repeating play* on page 25.

### 2 Press **FUNCTION** to select ITS-P.

Press **FUNCTION** until **ITS-P** appears in the display.

### 3 Press ▲ to turn ITS play on.

**ITS-P.ON** appears in the display. Playback begins of those tracks from your playlist within the previously selected **MCD** or **DSC** ranges.

- If no tracks in the current range are programmed for ITS play then **EMPTY** is displayed.

### 4 Press ▼ to turn ITS play off.

**ITS-P.OFF** appears in the display. Playback will continue in normal order from the currently playing track and CD.

## Erasing a track from your ITS playlist

When you want to delete a track from your ITS playlist, you can if ITS play is on.

If ITS play is already on, skip to step 2. If ITS play is not already on, press **FUNCTION**.

### 1 Play the CD with the track you want to delete from your ITS playlist, and turn ITS play on.

Refer to *Playback from your ITS playlist* on this page.

### 2 Press **FUNCTION** and hold until **TITLE IN** appears in the display, then press **FUNCTION** to select ITS.

After **TITLE IN** is displayed, press **FUNCTION** until **ITS** appears in the display.

### 3 Select the desired track by pressing ◀ or ▶.

### 4 Press ▼ to erase the track from your ITS playlist.

The currently playing selection is erased from your ITS playlist and playback of the next track from your ITS playlist begins.

- If there are no tracks from your playlist in the current range, **EMPTY** is displayed and normal play resumes.

### 5 Press **BAND** to return to the playback display.

## Erasing a CD from your ITS playlist

When you want to delete all tracks of a CD from your ITS playlist, you can if ITS play is off.

### 1 Play the CD that you want to delete.

Press ▲ or ▼ to select the CD.

### 2 Press FUNCTION and hold until TITLE IN appears in the display, then press FUNCTION to select ITS.

After TITLE IN is displayed, press FUNCTION until ITS appears in the display.

### 3 Press ▼ to erase all tracks on the currently playing CD from your ITS playlist.

All tracks on the currently playing CD are erased from your playlist and CLEAR is displayed.

### 4 Press BAND to return to the playback display.

## Using disc title functions

You can input CD titles and display the titles. Then you can easily search for and play a desired disc.

## Entering disc titles

Use the disc title input feature to store up to 100 CD titles (with ITS playlist) into the multi-CD player. Each title can be up to 8 characters long.

### 1 Play the CD that you want to enter a title for.

Press ▲ or ▼ to select the CD.

### 2 Press FUNCTION and hold until TITLE IN appears in the display.

After TITLE IN is displayed, press FUNCTION repeatedly, the following functions appear in the display:

**TITLE IN** (disc title input)—ITS (ITS programming)

- When playing a CD TEXT disc on a CD TEXT compatible multi-CD player, you cannot switch to **TITLE IN**. The disc title will have already been recorded on a CD TEXT disc.

### 3 Press ▲ or ▼ to select a letter of the alphabet.

Each press of ▲ will display a letter of the alphabet in **A B C ... X Y Z**, numbers and symbols in **1 2 3 ... > [ ]** order. Each press of ▼ will display a letter in the reverse order, such as **Z Y X ... C B A** order.



### 4 Press ► to move the cursor to the next character position.

When the letter you want is displayed, press ► to move the cursor to the next position and then select the next letter. Press ◀ to move backwards in the display.

### 5 Move the cursor to the last position by pressing ► after entering the title.

When you press ► one more time, the entered title is stored in memory.

### 6 Press BAND to return to the playback display.



#### Notes

- Titles remain in memory, even after the disc has been removed from the magazine, and are recalled when the disc is reinserted.

## Multi-CD Player

- After data for 100 discs has been stored in memory, data for a new disc will overwrite the oldest one.

### Displaying disc titles

You can display the title of any disc that has had a disc title entered.

- **Press DISPLAY.**

Press **DISPLAY** repeatedly to switch between the following settings:

Play time—**DISC TTL** (disc title)

When you select **DISC TTL**, the title of the currently playing disc is shown in the display.

- If no title has been entered for the currently playing disc, **NO TITLE** is displayed.

### Using CD TEXT functions

*You can use these functions only with a CD TEXT compatible multi-CD player.*

Some discs have certain information encoded on the disc during manufacture. These discs may contain such information as the CD title, track title, artist's name and playback time and are called CD TEXT discs. Only these specially encoded CD TEXT discs support the functions listed below.

### Displaying titles on CD TEXT discs

- **Press DISPLAY.**

Press **DISPLAY** repeatedly to switch between the following settings:

Play time—**DISC TTL** (disc title)—**ART NAME**

(disc artist name)—**TRK TTL** (track title)

—**ART NAME** (track artist name)

- If specific information has not been recorded on a CD TEXT disc, **NO XXXX** will be displayed (e.g., **NO D-TTL**).

### Scrolling titles in the display

This unit can display the first 8 letters only of **DISC TTL**, **ART NAME**, **TRK TTL** and **ART NAME**. When the recorded information is longer than 8 letters, you can scroll the text to the left so that the rest of the title can be seen.

- **Press DISPLAY and hold until the title begins to scroll to the left.**

The rest of the title will appear in the display.

### Using compression and bass emphasis

*You can use these functions only with a multi-CD player that supports them.*

Using **COMP** (compression) and **DBE** (dynamic bass emphasis) functions lets you adjust the sound playback quality of the multi-CD player. Each of the functions has a two-step adjustment. The **COMP** function balances the output of louder and softer sounds at higher volumes. **DBE** boosts bass levels to give playback a fuller sound. Listen to each of the effects as you select them and use the one that best enhances the playback of the track or CD that you are listening to.

- 1 **Press FUNCTION to select COMP.**

Press **FUNCTION** until **COMP** appears in the display.

- If the multi-CD player does not support **COMP/DBE**, **NO COMP** is displayed when you attempt to select it.

- 2 **Press ▲ or ▼ to select your favorite setting.**

Press **▲** or **▼** repeatedly to switch between the following settings:

**COMP OFF—COMP 1—COMP 2—**

**COMP OFF—DBE 1—DBE 2**

## Introduction of audio adjustments



### ① CUSTOM indicator

Shows when custom equalizer curve is currently selected.

### ② Audio display

Shows the audio adjustments status.

### ③ FIE indicator

Shows when the front image enhancer is turned on.

### ④ LOUD indicator

Appears in the display when loudness is turned on.

### ● Press AUDIO to display the audio function names.

Press **AUDIO** repeatedly to switch between the following audio functions:

**FAD** (balance adjustment)—**EQ** (equalizer)  
—**LOUD** (loudness)—**FIE** (front image enhancer)—**SLA** (source level adjustment)

- When selecting the FM tuner as the source, you cannot switch to **SLA**.
- To return to the display of each source, press **BAND**.



### Note

If you do not operate the audio function within about 30 seconds, the display is automatically returned to the source display.

## Using balance adjustment

You can select a fader/balance setting that provides an ideal listening environment in all occupied seats.

### 1 Press AUDIO to select FAD.

Press **AUDIO** until **FAD** appears in the display.

- If the balance setting has been previously adjusted, **BAL** will be displayed.

### 2 Press ▲ or ▼ to adjust front/rear speaker balance.

Each press of **▲** or **▼** moves the front/rear speaker balance towards the front or the rear.

**FAD F15 – FAD R15** is displayed as the front/rear speaker balance moves from front to rear.

- **FAD 0** is the proper setting when only two speakers are used.

### 3 Press ◀ or ▶ to adjust left/right speaker balance.

When you press **◀** or **▶**, **BAL 0** is displayed.

Each press of **◀** or **▶** moves the left/right speaker balance towards the left or the right.

**BAL L9 – BAL R9** is displayed as the left/right speaker balance moves from left to right.

## Using the equalizer

The equalizer lets you adjust the equalization to match car interior acoustic characteristics as desired.

## Recalling equalizer curves

There are six stored equalizer curves which you can easily recall at any time. Here is a list of the equalizer curves:

Display	Equalizer curve
<b>SPR-BASS</b>	Super bass
<b>POWERFUL</b>	Powerful

## Audio Adjustments

Display	Equalizer curve
NATURAL	Natural
VOCAL	Vocal
CUSTOM	Custom
EQ FLAT	Flat

- **CUSTOM** is an adjusted equalizer curve that you create.
- A separate **CUSTOM** curve can be created for each source. (The built-in CD player and the multi-CD player are set to the same equalizer adjustment setting automatically.) If you make adjustments, the equalizer curve settings will be memorized in **CUSTOM**.
- When **EQ FLAT** is selected no supplement or correction is made to the sound. This is useful to check the effect of the equalizer curves by switching alternatively between **EQ FLAT** and a set equalizer curve.

### ● Press EQ to select the equalizer.

Press **EQ** repeatedly to switch between the following equalizers:

**SPR-BASS—POWERFUL—NATURAL—  
VOCAL—CUSTOM—EQ FLAT**

## Adjusting equalizer curves

You can adjust the currently selected equalizer curve setting as desired. Adjusted equalizer curve settings are memorized in **CUSTOM**.

### 1 Press AUDIO to select EQ.

Press **AUDIO** until **EQ** appears in the display.

### 2 Press ◀ or ▶ to select the equalizer band to adjust.

Each press of ◀ or ▶ selects equalizer bands in the following order:

**EQ-L** (low)—**EQ-M** (mid)—**EQ-H** (high)

### 3 Press ▲ or ▼ to adjust the level of the equalizer band.

Each press of ▲ or ▼ increases or decreases the level of the equalization band.

**+6** – **–6** is displayed as the level is increased or decreased.

- You can then select another band and adjust the level.



### Note

If you make adjustments when a curve other than **CUSTOM** is selected, the newly adjusted curve will replace the previous curve. Then a new curve with **CUSTOM** appears on the display while selecting the equalizer curve.

## Fine-adjusting equalizer curve

You can adjust the center frequency and the Q factor (curve characteristics) of each currently selected curve band (**EQ-L/EQ-M/EQ-H**).

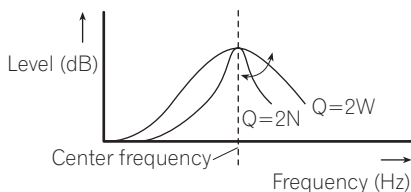

### 1 Press AUDIO and hold until frequency and the Q factor (e.g., F- 80.Q1W) appears in the display.

### 2 Press AUDIO to select the desired band for adjustment.

Low—Mid—High

### 3 Press ◀ or ▶ to select the desired frequency.

Press ◀ or ▶ until the desired frequency appears in the display.

## Audio Adjustments

Low: **40—80—100—160** (Hz)

Mid: **200—500—1k—2k** (Hz)

High: **3k—8k—10k—12k** (Hz)

### 4 Press ▲ or ▼ to select the desired Q factor.

Press ▲ or ▼ until the desired Q factor appears in the display.

**2N—1N—1W—2W**

#### Note

If you make adjustments when a curve other than **CUSTOM** is selected, the newly adjusted curve will replace the previous curve. Then a new curve with **CUSTOM** appears on the display while selecting the equalizer curve. 

## Adjusting loudness

Loudness compensates for deficiencies in the low- and high-sound ranges at low volume.

### 1 Press AUDIO to select LOUD.

Press **AUDIO** until **LOUD** appears in the display.

### 2 Press ▲ to turn loudness on.

Loudness level (e.g., **LOUD MID**) appears in the display.

### 3 Press ◀ or ▶ to select a desired level.

Each press of ◀ or ▶ selects level in the following order:

**LOW** (low)—**MID** (mid)—**HI** (high)

### 4 Press ▼ to turn loudness off.

**LOUD OFF** appears in the display.

#### Note

You can also turn loudness on or off by pressing **LOUDNESS**. 

## Front image enhancer (F.I.E.)

The F.I.E. (Front Image Enhancer) function is a simple method of enhancing front imaging by cutting mid- and high-range frequency output from the rear speakers, limiting their output to low-range frequencies. You can select the frequency you want to cut.

#### Precaution

When the F.I.E. function is deactivated, the rear speakers output sound of all frequencies, not just bass sounds. Reduce the volume before disengaging F.I.E. to prevent a sudden increase in volume.

### 1 Press AUDIO to select FIE.

Press **AUDIO** until **FIE** appears in the display.

### 2 Press ▲ to turn F.I.E. on.

- To turn F.I.E. off, press ▼.

### 3 Press ◀ or ▶ to select a desired frequency.

Each press of ◀ or ▶ selects frequency in the following order:

**100—160—250** (Hz)

#### Notes

- After turning the F.I.E. function on, use the balance adjustment (refer to page 30) and adjust front and rear speaker volume levels until they are balanced.
- Turn the F.I.E. function off when using a 2-speaker system. 

## Adjusting source levels

SLA (source level adjustment) lets you adjust the volume level of each source to prevent radical changes in volume when switching between sources.



## Audio Adjustments

- Settings are based on the FM tuner volume level, which remains unchanged.

**1 Compare the FM tuner volume level with the level of the source you wish to adjust.**

**2 Press AUDIO to select SLA.**

Press **AUDIO** until **SLA** appears in the display.

**3 Press ▲ or ▼ to adjust the source volume.**

Each press of ▲ or ▼ increases or decreases the source volume.

**SLA +4 – SLA –4** is displayed as the source volume is increased or decreased.



### Notes

- The AM tuner volume level can also be adjusted with source level adjustments.
- The built-in CD player and the multi-CD player are set to the same source level adjustment volume automatically.
- External unit 1 and external unit 2 are set to the same source level adjustment volume automatically. 

## Adjusting initial settings

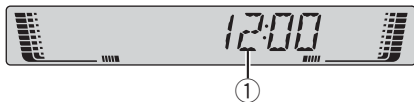

Initial settings lets you perform initial setup of different settings for this unit.

### ① Function display

Shows the function status.

**1 Press SOURCE and hold until the unit turns off.**

**2 Press FUNCTION and hold until the clock appears in the display.**

**3 Press FUNCTION to select one of the initial settings.**

Press **FUNCTION** repeatedly to switch between the following settings:

Clock—**AUX** (auxiliary input)

Use the following instructions to operate each particular setting.

- To cancel initial settings, press **BAND**.
- You can also cancel initial settings by holding down **FUNCTION** until the unit turns off. 

## Setting the clock

Use these instructions to set the clock.

**1 Press FUNCTION to select clock.**

Press **FUNCTION** repeatedly until clock appears in the display.

**2 Press ◀ or ▶ to select the segment of the clock display you wish to set.**

Pressing ◀ or ▶ will select one segment of the clock display:

Hour—Minute

As you select segments of the clock display the segment selected will blink.

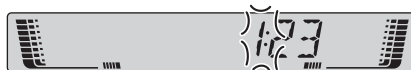

**3 Press ▲ or ▼ to set the clock.**

Pressing ▲ will increase the selected hour or minute. Pressing ▼ will decrease the selected hour or minute. 

## Switching the auxiliary setting

It is possible to use auxiliary equipment with this unit. Activate the auxiliary setting when using auxiliary equipment connected to this unit.

**1 Press FUNCTION to select AUX.**

Press **FUNCTION** repeatedly until **AUX** appears in the display.

**2 Press ▲ or ▼ to turn AUX on or off.**

Pressing ▲ or ▼ will turn **AUX** on or off and that status will be displayed (e.g., **AUX ON**). 

## Other Functions

### Turning the clock display on or off

You can turn the clock display on or off.

- **Press CLOCK to turn the clock display on or off.**

Each press of **CLOCK** turns the clock display on or off.

- The clock display disappears temporarily when you perform other operations, but the clock display appears again after 25 seconds.



#### Note

Even when the sources are off, the clock display appears on the display. Pressing **CLOCK** turns the clock display on or off. 

### Using the AUX source

An IP-BUS-RCA Interconnector such as the CD-RB20/CD-RB10 (sold separately) lets you connect this unit to auxiliary equipment featuring RCA output. For more details, refer to the IP-BUS-RCA Interconnector owner's manual.

### Selecting AUX as the source

- **Press SOURCE to select AUX as the source.**

Press **SOURCE** until **AUX** appears in the display.

- If the auxiliary setting is not turned on, **AUX** cannot be selected. For more details, see *Switching the auxiliary setting* on the previous page.

### Setting the AUX title

The title displayed for the **AUX** source can be changed.

**1 After you have selected AUX as the source, press FUNCTION and hold until TITLE IN appears in the display.**

**2 Press ▲ or ▼ to select a letter of the alphabet.**

Each press of ▲ will display a letter of the alphabet in **A B C ... X Y Z**, numbers and symbols in **1 2 3 ... > [ ]** order. Each press of ▼ will display a letter in the reverse order, such as **Z Y X ... C B A** order.



**3 Press ► to move the cursor to the next character position.**

When the letter you want is displayed, press ► to move the cursor to the next position and then select the next letter. Press ◀ to move backwards in the display.

**4 Move the cursor to the last position by pressing ► after entering the title.**

When you press ► one more time, the entered title is stored in memory.

**5 Press BAND to return to the playback display.** 

## Introduction of XM operation

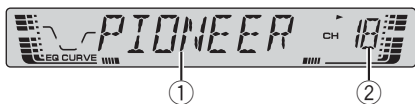

You can use this unit to control a XM satellite digital tuner (GEX-P910XM), which is sold separately.

For details concerning operation, refer to the XM tuner's operation manuals. This section provides information on XM operations with this unit which differs from that described in the XM tuner's operation manual.

### ① XM tuner information

Shows the XM tuner information which has been selected.

### ② XM channel number indicator

Shows to which XM channel number the tuner is tuned.

- If a channel number 100 to 199 is selected, ► on the left of the XM channel number indicator will light.
- If a channel number 200 or more is selected, ► on the left of the XM channel number indicator will blink.

## XM operation

XM operation of the following function with this unit differs.

- *Switching the XM channel select setting*  
(Refer to this page.)

## Switching the XM channel select setting

You can switch if you select a channel with a channel number or from a channel category when you select a channel.

1 Press **CLOCK** to select channel select setting.

2 Each press of **CLOCK** changes the channel select mode in the following order:  
**CHNUMBER** (channel number select setting)  
 — **CATEGORY** (channel category select setting) ▣

## Additional Information

### Understanding built-in CD player error messages

When you contact your dealer or your nearest Pioneer Service Center, be sure to record the error message.

Message	Cause	Action
<b>ERROR-11, 12, 17, 30</b>	Dirty disc	Clean disc.
<b>ERROR-11, 12, 17, 30</b>	Scratched disc	Replace disc.
<b>ERROR-10, 11, 12, 15, 17, 30, A0</b>	Electrical or mechanical	Turn the ignition ON and OFF, or switch to a different source, then back to the CD player.
<b>ERROR-15</b>	The inserted disc does not contain any data	Replace disc.
<b>ERROR-22, 23</b>	The CD format cannot be played back	Replace disc.
<b>ERROR-44</b>	All tracks are skip tracks	Replace disc.
<b>NO AUDIO</b>	The inserted disc does not contain any files that can be played back	Replace disc.
<b>SKIPPED</b>	The inserted disc contains WMA files that are protected by DRM	Replace disc.
<b>PROTECT</b>	All the files on the inserted disc are secured by DRM	Replace disc.



### CD player and care

- Use only CDs that have either of the two Compact Disc Digital Audio marks as shown below.



- Use only normal, round CDs. If you insert irregular, non-round, shaped CDs they may jam in the CD player or not play properly.



- Check all CDs for cracks, scratches or warping before playing. CDs that have cracks, scratches or are warped may not play properly. Do not use such discs.
- Avoid touching the recorded (non-printed) surface when handling the disc.
- Store discs in their cases when not in use.
- Keep discs out of direct sunlight and do not expose the discs to high temperatures.
- Do not attach labels, write on or apply chemicals to the surface of the discs.
- To clean a CD, wipe the disc with a soft cloth outward from the center.



- If the heater is used in cold weather, moisture may form on components inside the CD player. Condensation may cause the CD player to malfunction. If you think that condensation is a problem turn off the CD player for an hour or so to allow it to dry out and wipe any damp discs with a soft cloth to remove the moisture.
- Road shocks may interrupt CD playback. ■

## Additional Information

### CD-R/CD-RW discs

- When CD-R/CD-RW discs are used, playback is possible only for discs which have been finalized.
- It may not be possible to play back CD-R/CD-RW discs recorded on a music CD recorder or a personal computer because of disc characteristics, scratches or dirt on the disc, or dirt, condensation, etc., on the lens of this unit.
- Playback of discs recorded on a personal computer may not be possible, depending on the application settings and the environment. Please record with the correct format. (For details, contact the manufacturer of the application.)
- Playback of CD-R/CD-RW discs may become impossible in case of direct exposure to sunlight, high temperatures, or the storage conditions in the vehicle.
- Titles and other text information recorded on a CD-R/CD-RW disc may not be displayed by this unit (in the case of audio data (CD-DA)).
- This unit conforms to the track skip function of the CD-R/CD-RW disc. The tracks containing the track skip information are skipped automatically (in case of audio data (CD-DA)).
- If you insert a CD-RW disc into this unit, time to playback will be longer than when you insert a conventional CD or CD-R disc.
- Read the precautions with CD-R/CD-RW discs before using them. ▣

### MP3, WMA and WAV files

- MP3 is short for MPEG Audio Layer 3 and refers to an audio compression technology standard.
- WMA is short for Windows Media™ Audio and refers to an audio compression technology that is developed by Microsoft Corporation. WMA data can be encoded by using Windows Media Player version 7 or later.
- WAV is short for waveform. It is a standard audio file format for Windows®.
- With some applications used to encode WMA files, this unit may not operate correctly.
- Depending on the version of Windows Media Player used to encode WMA files, album names and other text information may not be correctly displayed.
- There may be a slight delay when starting playback of WMA files encoded with image data.
- This unit allows playback of MP3/WMA/WAV files on CD-ROM, CD-R and CD-RW discs. Disc recordings compatible with level 1 and level 2 of ISO9660 and with the Romeo and Joliet file system can be played back.
- It is possible to play back multi-session compatible recorded discs.
- MP3/WMA/WAV files are not compatible with packet write data transfer.
- The maximum number of characters which can be displayed for a file name, including the extension (.mp3, .wma or .wav), is 64, from the first character.
- The maximum number of characters which can be displayed for a folder name is 64.
- In case of files recorded according to the Romeo file system, only the first 64 characters can be displayed.
- When playing discs with MP3/WMA/WAV files and audio data (CD-DA) such as CD-EXTRA and MIXED-MODE CDs, both types can be played only by switching mode between MP3/WMA/WAV and CD-DA.
- The folder selection sequence for playback and other operations becomes the writing sequence used by the writing software. For this reason, the expected sequence at the time of playback may not coincide with the actual playback sequence. However, there also is some writing software which permits setting of the playback order.

## Additional Information

- Some audio CDs contain tracks that merge into one another without a pause. When these discs are converted to MP3/WMA/WAV files and burned to a CD-R/CD-RW/CD-ROM, the files will be played back on this player with a short pause between each one, regardless of the length of the pause between tracks on the original audio CD.

### Important

- When naming an MP3/WMA/WAV file, add the corresponding filename extension (.mp3, .wma or .wav).
- This unit plays back files with the filename extension (.mp3, .wma or .wav) as an MP3/WMA/WAV file. To prevent noise and malfunctions, do not use these extensions for files other than MP3/WMA/WAV files.

### MP3 additional information

- Files are compatible with the ID3 Tag Ver. 1.0, 1.1, 2.2, 2.3 and 2.4 formats for display of album (disc title), track (track title), artist (track artist) and comments. Ver. 2.x of ID3 Tag is given priority when both Ver. 1.x and Ver. 2.x exist.
- The emphasis function is valid only when MP3 files of 32, 44.1 and 48 kHz frequencies are played back. (16, 22.05, 24, 32, 44.1, 48 kHz sampling frequencies can be played back.)
- There is no m3u playlist compatibility.
- There is no compatibility with the MP3i (MP3 interactive) or mp3 PRO formats.
- The sound quality of MP3 files generally becomes better with an increased bit rate. This unit can play recordings with bit rates from 8 kbps to 320 kbps, but in order to be able to enjoy sound of a certain quality, we recommend using only discs recorded with a bit rate of at least 128 kbps.

### WMA additional information

- This unit plays back WMA files encoded by Windows Media Player version 7, 7.1, 8 and 9.
- You can only play back WMA files in the frequencies 32, 44.1 and 48 kHz.
- The sound quality of WMA files generally becomes better with an increased bit rate. This unit can play recordings with bit rates from 48 kbps to 320 kbps (CBR) or from 48 kbps to 384 kbps (VBR), but in order to be able to enjoy sound of a certain quality, we recommend using discs recorded with a higher bit rate.
- This unit doesn't support the following formats.
  - Windows Media Audio 9 Professional (5.1ch)
  - Windows Media Audio 9 Lossless
  - Windows Media Audio 9 Voice

### WAV additional information

- This unit plays back WAV files encoded in Linear PCM (LPCM) format or MS ADPCM format.
- You can only play back WAV files in the frequencies 16, 22.05, 24, 32, 44.1 and 48 kHz (LPCM), or 22.05 and 44.1 kHz (MS ADPCM). The sampling frequency shown in the display may be rounded.
- The sound quality of WAV files generally becomes better with a larger number of quantization bits. This unit can play recordings with 8 and 16 (LPCM) or 4 (MS ADPCM) quantization bits, but in order to be able to enjoy sound of a certain quality, we recommend using discs recorded with the larger number of quantization bits. 

## Additional Information

### About folders and MP3/WMA/WAV files

- An outline of a CD-ROM with MP3/WMA/WAV files on it is shown below. Subfolders are shown as folders in the folder currently selected.

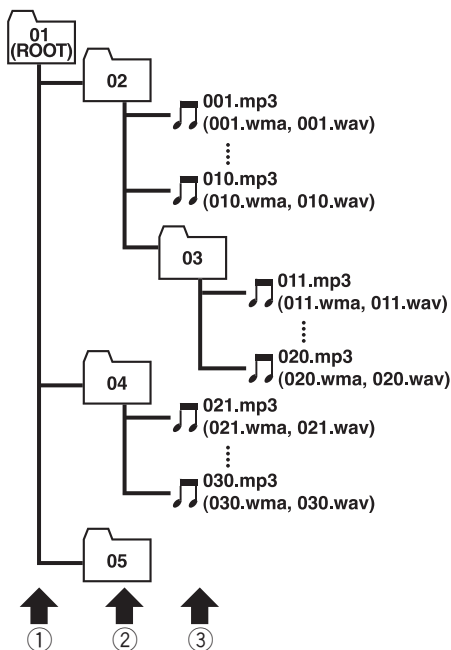

- ① First level
- ② Second level
- ③ Third level

#### Notes

- This unit assigns folder numbers. The user can not assign folder numbers.
- It is not possible to check folders that do not include MP3/WMA/WAV files. (These folders will be skipped without displaying the folder number.)

- MP3/WMA/WAV files in up to 8 tiers of folders can be played back. However, there is a delay in the start of playback on discs with numerous tiers. For this reason we recommend creating discs with no more than 2 tiers.
- It is possible to play back up to 99 folders on one disc.



## Additional Information

### Terms

#### Bit rate

This expresses data volume per second, or bps units (bits per second). The higher the rate, the more information is available to reproduce the sound. Using the same encoding method (such as MP3), the higher the rate, the better the sound.

#### ID3 tag

This is a method of embedding track-related information in an MP3 file. This embedded information can include the track title, the artist's name, the album title, the music genre, the year of production, comments and other data. The contents can be freely edited using software with ID3 Tag editing functions. Although the tags are restricted as to the number of characters, the information can be viewed when the track is played back.

#### ISO9660 format

This is the international standard for the format logic of CD-ROM folders and files. For the ISO9660 format, there are regulations for the following two levels.

##### Level 1:

The file name is in 8.3 format (the name consists of up to 8 characters, half-byte English capital letters and half-byte numerals and the “\_” sign, with a file-extension of three characters).

##### Level 2:

The file name can have up to 31 characters (including the separation mark “.” and a file extension). Each folder contains less than 8 hierarchies.

#### Extended formats

Joliet:

File names can have up to 64 characters.

Romeo:

File names can have up to 128 characters.

#### Linear PCM (LPCM)/Pulse code modulation

This stands for linear pulse code modulation, which is the signal recording system used for music CDs and DVDs.

#### m3u

Playlists created using the “WINAMP” software have a playlist file extension (.m3u).

#### MP3

MP3 is short for MPEG Audio Layer 3. It is an audio compression standard set by a working group (MPEG) of the ISO (International Standards Organization). MP3 is able to compress audio data to about 1/10th the level of a conventional disc.

#### MS ADPCM

This stands for Microsoft adaptive differential pulse code modulation, which is the signal recording system used for the multimedia software of Microsoft Corporation.

#### Multi-session

Multi-session is a recording method that allows additional data to be recorded later. When recording data on a CD-ROM, CD-R or CD-RW, etc., all data from beginning to end is treated as a single unit or session. Multi-session is a method of recording more than 2 sessions on one disc.

#### Number of quantization bits

The sound quality of WAV files generally becomes better with a larger number of quantization bits. This unit can play recordings with 8 and 16 (LPCM) or 4 (MS ADPCM) quantization bits, but in order to be able to enjoy sound of a certain quality, we recommend using discs recorded with the larger number of quantization bits.

## Additional Information

### **Packet write**

This is a general term for a method of writing on CD-R, etc., at the time required for a file, just as is done with files on floppy or hard discs.

### **VBR**

VBR is short for variable bit rate. Generally speaking CBR (constant bit rate) is more widely used. But by flexibly adjusting the bit rate according to the needs of audio compression, it is possible to achieve compression-priority sound quality.

### **WAV**

WAV is short for waveform. It is a standard audio file format for Windows®.

### **WMA**

WMA is short for Windows Media™ Audio and refers to an audio compression technology that is developed by Microsoft Corporation. WMA data can be encoded by using Windows Media Player version 7 or later. Microsoft, Windows Media, and the Windows logo are trademarks, or registered trademarks of Microsoft Corporation in the United States and/or other countries. ■

# Additional Information

## Specifications

### General

Power source .....	14.4 V DC (10.8 – 15.1 V allowable)
Grounding system .....	Negative type
Max. current consumption .....	10.0 A
Dimensions (W × H × D):	
DIN	
Chassis .....	178 × 50 × 157 mm (7 × 2 × 6-1/8 in.)
Nose .....	188 × 58 × 19 mm (7-3/8 × 2-1/4 × 3/4 in.)
D	
Chassis .....	178 × 50 × 162 mm (7 × 2 × 6-3/8 in.)
Nose .....	170 × 46 × 14 mm (6-3/4 × 1-3/4 × 1/2 in.)
Weight .....	1.3 kg (2.86 lbs)

### Audio

Continuous power output is 22 W per channel minimum into 4 ohms, both channels driven 50 to 15,000 Hz with no more than 5% THD.

Maximum power output .....	50 W × 4
Load impedance .....	4 Ω (4 – 8 Ω allowable)
Preout max output level/output impedance .....	2.2 V/1 kΩ

Equalizer (3-Band Parametric Equalizer):

Low	
Frequency .....	40/80/100/160 Hz
Q Factor .....	0.35/0.59/0.95/1.15 (+6 dB when boosted)
Gain .....	±12dB
Mid	
Frequency .....	200/500/1k/2k Hz
Q Factor .....	0.35/0.59/0.95/1.15 (+6 dB when boosted)
Gain .....	±12dB
High	
Frequency .....	3.15k/8k/10k/12.5k Hz
Q Factor .....	0.35/0.59/0.95/1.15 (+6 dB when boosted)
Gain .....	±12dB

Loudness contour:

Low .....	+3.5 dB (100 Hz), +3 dB (10 kHz)
Mid .....	+10 dB (100 Hz), +6.5 dB (10 kHz)

High .....	+11 dB (100 Hz), +11 dB (10 kHz) (volume: –30 dB)
------------	--

### CD player

System .....	Compact disc audio system
Usable discs .....	Compact disc
Signal format:	
Sampling frequency .....	44.1 kHz
Number of quantization bits .....	16; linear
Frequency characteristics .....	5 – 20,000 Hz (±1 dB)
Signal-to-noise ratio .....	94 dB (1 kHz) (IHF-A network)
Dynamic range .....	92 dB (1 kHz)
Number of channels .....	2 (stereo)
MP3 decoding format .....	MPEG-1 & 2 Audio Layer 3
WMA decoding format .....	Ver. 7, 7.1, 8, 9 (2ch audio)
WAV signal format .....	Linear PCM & MS ADPCM

### FM tuner

Frequency range .....	87.9 – 107.9 MHz
Usable sensitivity .....	8 dBf (0.7 μV/75 Ω, mono, S/N: 30 dB)
50 dB quieting sensitivity .....	10 dBf (0.9 μV/75 Ω, mono)
Signal-to-noise ratio .....	75 dB (IHF-A network)
Distortion .....	0.3 % (at 65 dBf, 1 kHz, stereo) 0.1 % (at 65 dBf, 1 kHz, mono)
Frequency response .....	30 – 15,000 Hz (±3 dB)
Stereo separation .....	45 dB (at 65 dBf, 1 kHz)
Selectivity .....	80 dB (±200 kHz)
Three-signal intermodulation (desired signal level) .....	30 dBf (two undesired signal level: 100 dBf)

### AM tuner

Frequency range .....	530 – 1,710 kHz (10 kHz)
Usable sensitivity .....	18 μV (S/N: 20 dB)
Signal-to-noise ratio .....	65 dB (IHF-A network)



### Note

Specifications and the design are subject to possible modifications without notice due to improvements. □

*Register your product at  
Enregistrez votre produit au  
Registre su producto en*

***<http://www.pioneerelectronics.com>***

*See "Product registration" page  
Voir la page "Enregistrement du produit"  
Consulte la página sobre "Registro del producto"*

## **PIONEER CORPORATION**

4-1, MEGURO 1-CHOME, MEGURO-KU, TOKYO 153-8654, JAPAN

### **PIONEER ELECTRONICS (USA) INC.**

P.O. Box 1540, Long Beach, California 90801-1540, U.S.A.  
TEL: (800) 421-1404

### **PIONEER EUROPE NV**

Haven 1087, Keetberglaan 1, B-9120 Melsele, Belgium  
TEL: (0) 3/570.05.11

### **PIONEER ELECTRONICS ASIACENTRE PTE. LTD.**

253 Alexandra Road, #04-01, Singapore 159936  
TEL: 65-6472-7555

### **PIONEER ELECTRONICS AUSTRALIA PTY. LTD.**

178-184 Boundary Road, Braeside, Victoria 3195, Australia  
TEL: (03) 9586-6300

### **PIONEER ELECTRONICS OF CANADA, INC.**

300 Allstate Parkway, Markham, Ontario L3R OP2, Canada  
TEL: 1-877-283-5901

### **PIONEER ELECTRONICS DE MEXICO, S.A. de C.V.**

Bvd.Manuel Avila Camacho 138 10 piso  
Col.Lomas de Chapultepec, Mexico, D.F. 11000  
TEL: 55-9178-4270

### **先鋒股份有限公司**

總公司：台北市中山北路二段44號13樓  
電話：(02) 2521-3588

### **先鋒電子（香港）有限公司**

香港九龍尖沙咀海港城世界商業中心  
9樓901-6室  
電話：(0852) 2848-6488

Published by Pioneer Corporation.  
Copyright © 2004 by Pioneer Corporation.  
All rights reserved.

Publié par Pioneer Corporation. Copyright  
© 2004 par Pioneer Corporation. Tous  
droits réservés.

Printed in China  
Imprimé en Chine

# DEH-P3700MP

This product conforms to CEMA cord colors.  
Le code de couleur des câbles utilisé pour ce produit est conforme à CEMA.  
Los colores de los cables este producto se conforman con el código de colores CEMA.

## Connecting the Units

### Note:

- This unit is for vehicles with a 12-volt battery and negative grounding. Before installing it in a recreational vehicle, truck or bus, check the battery voltage.
- To avoid shorts in the electrical system, be sure to disconnect the  $\ominus$  battery cable before beginning installation.
- Refer to the owner's manual for details on connecting the power amp and other units, then make connections correctly.
- Secure the wiring with cable clamps or adhesive tape. To protect the wiring, wrap adhesive tape around them where they lie against metal parts.
- Route and secure all wiring so it cannot touch any moving parts, such as the gear shift, handbrake and seat rails. Do not route wiring in places that get hot, such as near the heater outlet. If the insulation of the wiring melts or gets torn, there is a danger of the wiring short-circuiting to the vehicle body.
- Don't pass the yellow lead through a hole into the engine compartment to connect to the battery. This will damage the lead insulation and cause a very dangerous short.
- Do not shorten any leads. If you do, the protection circuit may fail to work when it should.
- Never feed power to other equipment by cutting the insulation of the power supply lead of the unit and tapping into the lead. The current capacity of the lead will be exceeded, causing overheating.
- When replacing the fuse, be sure to only use a fuse of the rating prescribed on this unit.
- Since a unique BPTL circuit is employed, never wire so the speaker leads are directly grounded or the left and right  $\ominus$  speaker leads are common. If you ground the products together and the ground becomes detached, there is a risk of damage to the products or fire.
- The black lead is ground. Please ground this lead separately from the ground of high-current products such as power amps. If you ground the products together and the ground becomes detached, there is a risk of damage to the products or fire.
- Speakers connected to this unit must be high-power with minimum rating of 50 W and impedance of 4 to 8 ohms. Connecting speakers with output and/or impedance values other than those noted here may result in the speakers catching fire, emitting smoke, or becoming damaged.

- When this product's source is switched ON, a control signal is output through the blue/white lead. Connect to an external power amp's system remote control or the car's Auto-antenna relay control terminal (max. 300 mA 12 V DC). If the car features a glass antenna, connect to the antenna booster power supply terminal.
- When an external power amp is being used with this system, be sure not to connect the blue/white lead to the amp's power terminal. Likewise, do not connect the blue/white lead to the power terminal of the auto-antenna. Such connection could cause excessive current drain and malfunction.
- To avoid a short-circuit, cover the disconnected lead with insulating tape. Insulate the unused speaker leads without fail. There is a possibility of a short-circuit if the leads are not insulated.
- To prevent incorrect connection, the input side of the IP-BUS connector is blue, and the output side is black. Connect the connectors of the same colors correctly.
- If this unit is installed in a vehicle that does not have an ACC (accessory) position on the ignition switch, the red lead of the unit should be connected to a terminal coupled with ignition switch ON/OFF operations. If this is not done, the vehicle battery may be drained when you are away from the vehicle for several hours. (Fig. 1)

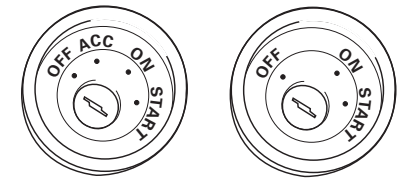

ACC position

No ACC position

Fig. 1

- Cords for this product and those for other products may be different colors even if they have the same function. When connecting this product to another product, refer to the supplied manuals of both products and connect cords that have the same function.

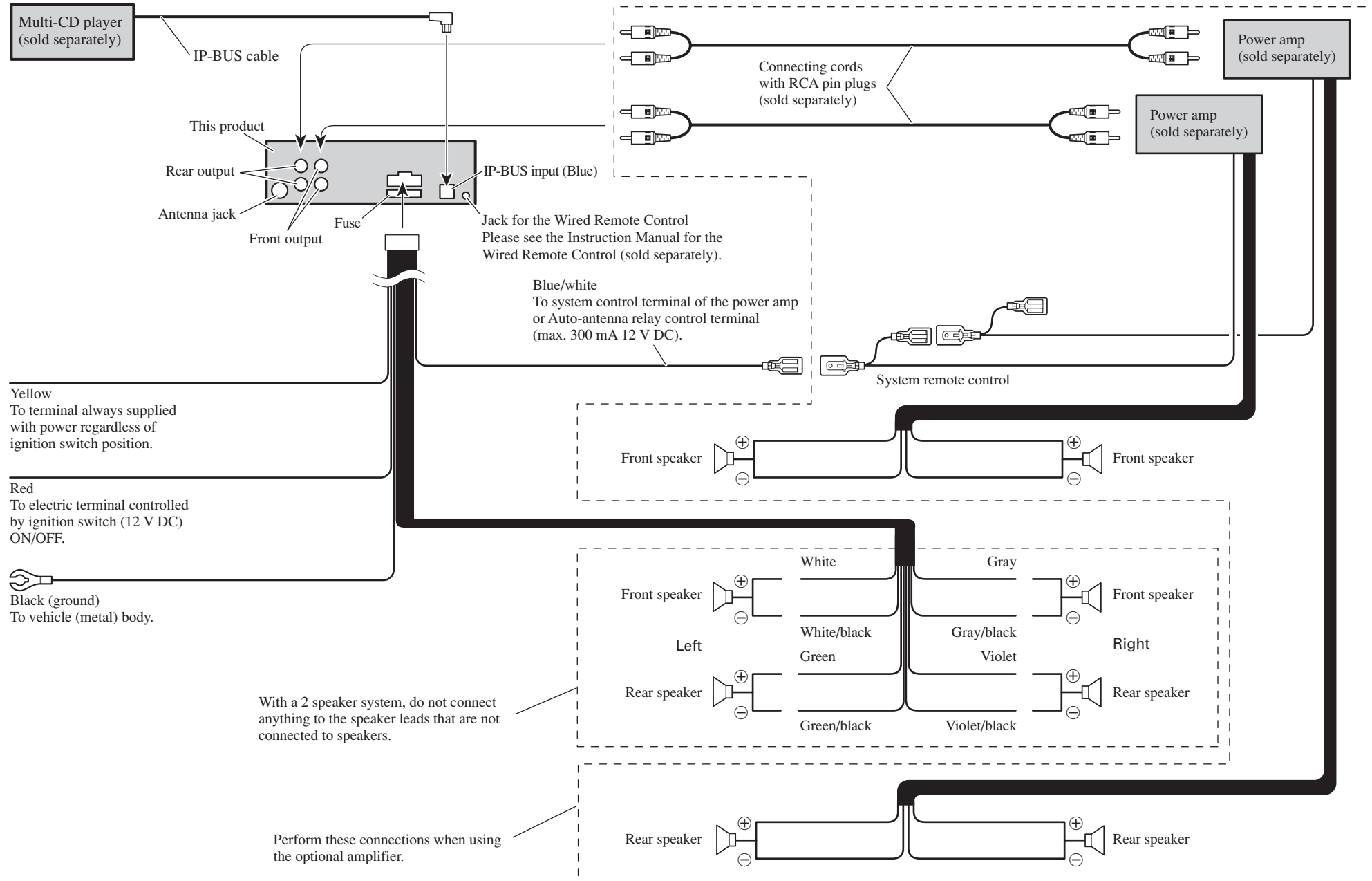

Fig. 2

## Installation

### Note:

- Before making a final installation of the unit, temporarily connect the wiring to confirm that the connections are correct and the system works properly.
- Use only the parts included with the unit to ensure proper installation. The use of unauthorized parts can cause malfunctions.
- Consult with your nearest dealer if installation requires the drilling of holes or other modifications of the vehicle.
- Install the unit where it does not get in the driver's way and cannot injure the passenger if there is a sudden stop, like an emergency stop.
- The semiconductor laser will be damaged if it overheats, so don't install the unit anywhere hot — for instance, near a heater outlet.
- If installation angle exceeds 60° from horizontal, the unit might not give its optimum performance. (Fig. 3)

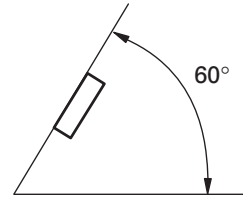

Fig. 3

### DIN Front/Rear-mount

This unit can be properly installed either from “Front” (conventional DIN Front-mount) or “Rear” (DIN Rear-mount installation, utilizing threaded screw holes at the sides of unit chassis). For details, refer to the following illustrated installation methods.

### DIN Front-mount

#### Installation with the rubber bush (Fig. 4)

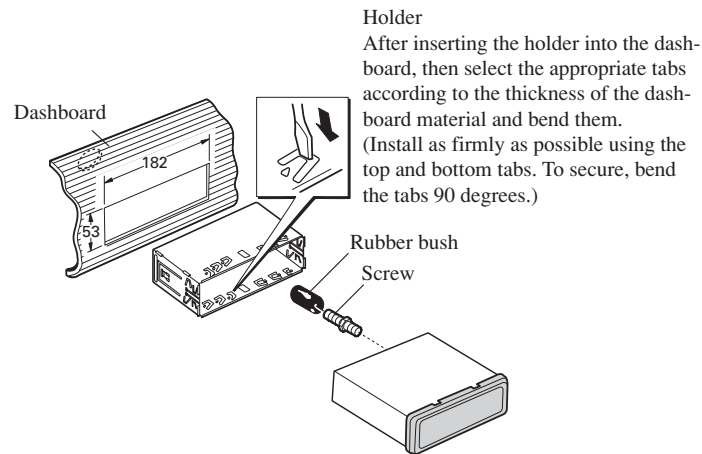
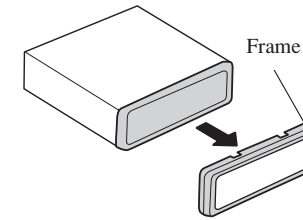

Fig. 4

#### Removing the Unit (Fig. 5) (Fig. 6)



To remove the frame, extend top and bottom of the frame outwards in order to unlock it. (When reattaching the frame, point the side with a groove downwards and attach it.)

- It becomes easy to remove the frame if the front panel is released.

Fig. 5

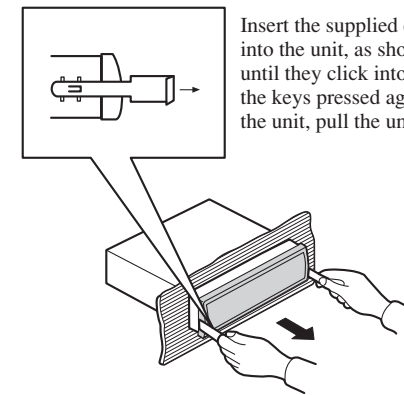

Fig. 6

## DIN Rear-mount

### Installation using the screw holes on the side of the unit

#### 1. Remove the frame. (Fig. 7)

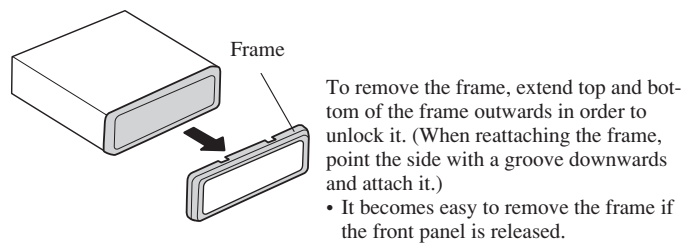

Fig. 7

#### 2. Fastening the unit to the factory radio mounting bracket. (Fig. 8) (Fig. 9)

Select a position where the screw holes of the bracket and the screw holes of the head unit become aligned (are fitted), and tighten the screws at 2 places on each side. Use either truss screws (5 × 8 mm) or flush surface screws (5 × 9 mm), depending on the shape of the screw holes in the bracket.

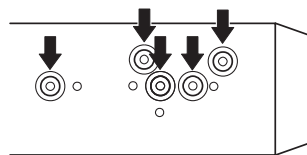

Fig. 8

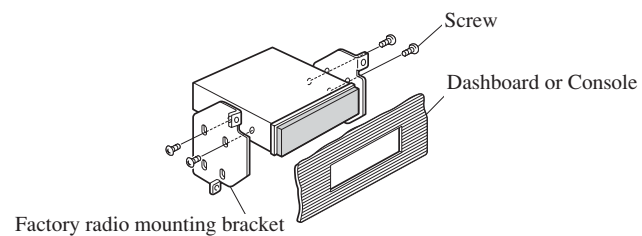

Fig. 9

### About the fixing screws for the front panel

If you do not operate the Detaching and Replacing the Front Panel Function, use the supplied fixing screws and fix the front panel to this unit.

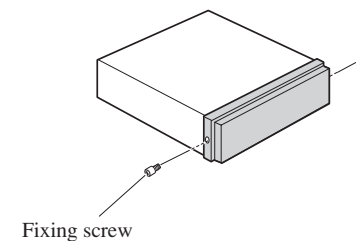

Fig. 10



## Note:

Before installing this unit in your vehicle, refer to the illustration below and remove the tag.  
Do not use the parts you have removed (screws etc.) when installing the unit in your vehicle.

## Remarque:

Avant d'installer cet appareil dans votre voiture, reportez-vous à l'illustration ci-dessous et retirez cette cosse.

N'utilisez pas les pièces que vous avez retirées (vis, etc.) lors de l'installation de l'appareil dans votre voiture.

## Nota:

Antes de instalar esta unidad en su vehículo, refiérase a la ilustración abajo y quite la pieza.  
No utilice las partes retiradas (tornillos, etc.) al instalar la unidad en su vehículo.

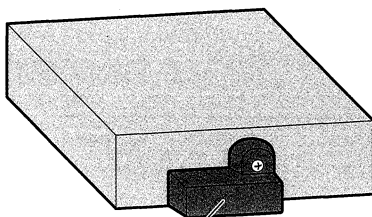

Tag  
Cosse  
Pieza

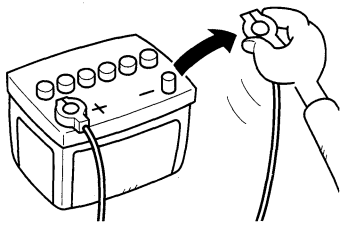

Fig.1

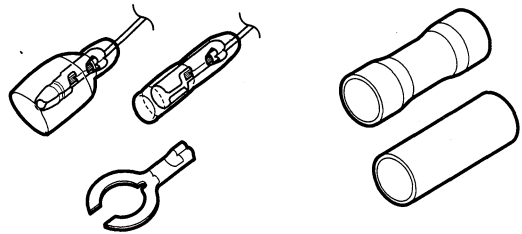

Fig.2

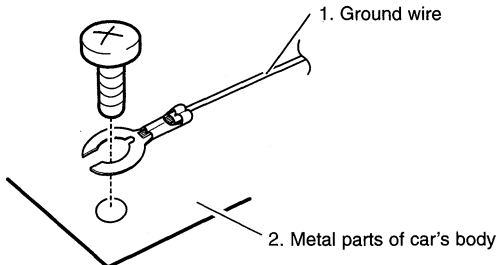

Fig.3

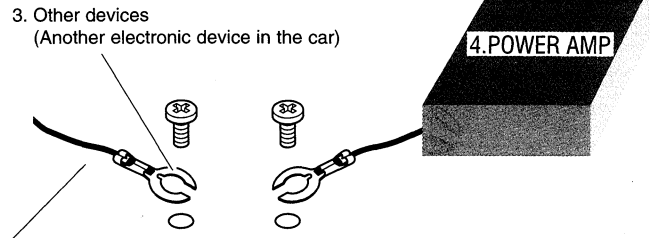

Fig.4

## WARNING

Always follow the instructions below when connecting or installing parts. Not following the instructions below may result in the malfunction of this unit. Additionally, if the parts to this unit malfunction the unit may emit smoke or catch fire.

- Always remove a connector from the  $\ominus$  battery terminal before beginning any connection or installing work. (Fig.1)
- Ensure that the power cord, the ground wire and the speaker are all properly connected. We recommend that you use a plug and a receptacle, solderless contact and a Y connector. (Fig.2)
- When installing this unit, always connect the ground wire first. Ensure that the ground wire is properly connected to metal parts of the car's body. (Fig.3)
  1. Ground wire
  2. Metal parts of car's body
- Connect to this unit only high-powered speakers of over 50W and with impedance between 4 and 8 ohms. Though there are speaker systems with low impedance between 1 and 3 ohms, you must not connect these to this unit.
- When connecting the power amp (sold separately) to this unit ensure that the ground wire for the power amp is properly connected to metal parts of the car's body. Connect the ground wire of the power amp with a different screw from the one you used to connect the ground wire for this unit or any other device. Should the screw for the power amp's ground wire loosen or fall out, it may result in this unit emitting smoke or malfunctioning. (Fig.4)
- 3. Other devices (Another electronic device in the car)
- 4. POWER AMP
- Cover any terminals not connected with insulation tape so they do not make contact with metal.
- Do not change the speaker connections while this unit is in operation.

If you have any questions regarding the connection or installation or parts, consult your local dealer.

## ADVERTENCIA

Siga siempre estas instrucciones antes de conectar o instalar piezas. De lo contrario, puede que esta unidad no funcione correctamente. Además, si las piezas de esta unidad no funcionan correctamente, la unidad puede expulsar humo o fuego.

- Extraiga siempre un conector del terminal de batería  $\ominus$  antes de realizar cualquier conexión o instalación. (Fig.1)
- Asegúrese de que el cable de corriente, el cable de conexión a tierra y el altavoz están correctamente conectados. Le recomendamos que utilice un enchufe y un receptáculo, un contacto sin soldadura y un conector en Y. (Fig.2)
- Cuando instale esta unidad, conecte siempre el cable de conexión a tierra en primer lugar. Asegúrese de que el cable de conexión a tierra está correctamente conectado a las partes metálicas de la carrocería del automóvil. (Fig.3)
  1. Cable de conexión a tierra
  2. Partes metálicas de la carrocería del automóvil
- Conecte a esta unidad únicamente altavoces de alta potencia, de más de 50 W y con una impedancia de entre 4 y 8 ohmios. Aunque existen sistemas de altavoces con baja impedancia entre 1 y 3 ohmios, no debe conectarlos a esta unidad.
- Cuando conecte el amplificador de potencia (vendido por separado) a esta unidad, asegúrese de que el cable de conexión a tierra del amplificador de potencia está conectado correctamente a las partes metálicas de la carrocería del automóvil. Conecte el cable de conexión a tierra del amplificador de potencia con un tornillo distinto del utilizado para conectar el cable de conexión a tierra de esta unidad o cualquier otro dispositivo. En caso de que el tornillo del cable de conexión a tierra del amplificador de potencia se afloje o se suelte, la unidad puede expulsar humo o dejar de funcionar correctamente. (Fig.4)
- 3. Otros dispositivos (otro dispositivo electrónico del automóvil)
- 4. AMPLIFICADOR DE POTENCIA
- Cubra cualquier terminal no conectado con cinta aislante para que no haga contacto con el metal.
- No cambie las conexiones del altavoz mientras esta unidad esté en funcionamiento.

Si tiene alguna pregunta en relación con la conexión o la instalación de piezas, consulte a su distribuidor local.

## AVERTISSEMENT

Veillez toujours suivre les instructions indiquées ci-dessous lors du branchement ou de l'installation des pièces. Ne pas suivre les instructions indiquées ci-dessous peut entraîner un mauvais fonctionnement de l'unité. En outre, si les pièces de cette unité fonctionnent mal, de la fumée pourra sortir de l'unité ou cette dernière pourra prendre feu.

- Assurez-vous de toujours enlever un connecteur de la prise  $\ominus$  de la batterie avant de effectuer un branchement ou un travail d'installation. (Fig.1)
- Assurez-vous que le cordon d'alimentation, le fil de terre et l'enceinte sont branchés correctement. Nous vous recommandons d'utiliser une fiche et une prise de courant (femelle), un contact sans soudure et un raccord en Y. (Fig.2)
- Quand vous installez l'unité, veuillez toujours brancher le fil de terre en premier. Assurez-vous que le fil de terre est branché correctement aux pièces métalliques de la carrosserie de la voiture. (Fig.3)
  1. Fil de terre
  2. Pièces métalliques de la carrosserie de la voiture
- Assurez-vous de ne brancher à cette unité que des enceintes à haute puissance de plus de 50 W et d'une impédance entre 4 et 8 ohms. Même s'il existe des systèmes d'enceintes avec une impédance basse entre 1 et 3 ohms, vous ne devez pas brancher ce type d'enceintes à l'unité.
- Quand vous branchez l'amplificateur de puissance (vendu séparément) à cette unité, assurez-vous que le fil de terre de l'amplificateur de puissance est branché correctement aux pièces métalliques de la carrosserie de la voiture. Branchez le fil de terre de l'amplificateur de puissance avec un tournevis différent de celui que vous avez utilisé pour brancher le fil de terre à l'unité ou un autre dispositif. Si la vis du fil de terre de l'amplificateur de puissance se desserre ou tombe, de la fumée pourra sortir de l'unité ou elle fonctionnera mal. (Fig.4)
- 3. Autres dispositifs (Un autre dispositif électronique dans la voiture)
- 4. AMPLIFICATEUR DE PUISSANCE
- Couvrez toutes les prises qui ne sont pas branchées avec du ruban isolant pour qu'elles ne soient pas en contact avec du métal.
- Ne changez pas les branchements de l'enceinte quand l'unité est en marche.

Si vous avez des questions sur le branchement ou l'installation des pièces, veuillez consulter votre revendeur local.

## ADVERTÊNCIA

Siga sempre as seguintes instruções quando realizar a ligação ou instalação de peças. O não cumprimento das seguintes instruções pode resultar no funcionamento incorrecto desta unidade. Para além disso, se as peças desta unidade não funcionarem correctamente, a unidade pode produzir fumo e incendiar.

- Retire sempre um ligador do terminal da bateria  $\ominus$  antes de realizar qualquer trabalho de ligação ou instalação. (Fig.1)
- Certifique-se de que o cabo de alimentação, o fio terra e a coluna estão devidamente ligados. Recomendamos a utilização de uma ficha e de uma tomada, de um contacto sem solda e de um conector em Y. (Fig.2)
- Quando instalar esta unidade, ligue sempre em primeiro lugar o fio terra. Certifique-se de que o fio terra está devidamente ligado a partes metálicas da carroçaria do automóvel. (Fig.3)
  1. Fio terra
  2. Peças metálicas da carroçaria do automóvel
- Ligue a esta unidade apenas a colunas de elevado desempenho com potência superior a 50W e com impedância entre 4 e 8 ohms. Embora existam colunas com baixa impedância, entre 1 e 3 ohms, não deve ligá-las a esta unidade.
- Quando ligar o amplificador (vendido em separado) a esta unidade, certifique-se de que o fio terra para o amplificador está devidamente ligado a peças metálicas da carroçaria do automóvel. Ligue o fio terra do amplificador com um parafuso diferente do utilizado para ligar o fio terra a esta unidade ou a qualquer outro dispositivo. Se o parafuso do amplificador se soltar ou cair, poderá fazer com que a unidade comece a deitar fumo ou a funcionar mal. (Fig.4)
- 3. Outros dispositivos (Outra unidade electrónica no automóvel)
- 4. AMPLIFICADOR
- Tape todos os terminais não ligados com fita isoladora de forma a que não fiquem em contacto com o metal.
- Não mude as ligações das colunas enquanto a unidade estiver a funcionar.

Em caso de dúvidas relacionadas com a ligação ou instalação de peças, consulte o seu distribuidor local.

<KMMNF> <CRP1310-AU>



PIONEER ELECTRONICS (USA) INC.

PIONEER ELECTRONICS OF CANADA, INC.

LIMITED WARRANTY

WARRANTY VALID ONLY IN COUNTRY OF PRODUCT PURCHASE

WARRANTY

Pioneer Electronics (USA) Inc. (PUSA), and Pioneer Electronics Of Canada, Inc. (POC), warrant that products distributed by PUSA in the U.S.A., and by POC in Canada that fail to function properly under normal use due to a manufacturing defect when installed and operated according to the owner's manual enclosed with the unit will be repaired or replaced with a unit of comparable value, at the option of PUSA or POC, without charge to you for parts or actual repair work.

THIS LIMITED WARRANTY APPLIES TO THE ORIGINAL OR ANY SUBSEQUENT OWNER OF THIS PIONEER PRODUCT DURING THE WARRANTY PERIOD PROVIDED THE PRODUCT WAS PURCHASED FROM AN AUTHORIZED PIONEER DISTRIBUTOR/DEALER IN THE U.S.A. OR CANADA. YOU WILL BE REQUIRED TO PROVIDE A SALES RECEIPT OR OTHER VALID PROOF OF PURCHASE SHOWING THE DATE OF ORIGINAL PURCHASE OR, IF RENTED, YOUR RENTAL CONTRACT SHOWING THE PLACE AND DATE OF FIRST RENTAL. IN THE EVENT SERVICE IS REQUIRED, THE PRODUCT MUST BE DELIVERED WITHIN THE WARRANTY PERIOD, TRANSPORTATION PREPAID, ONLY FROM WITHIN THE COUNTRY OF PURCHASE AS EXPLAINED IN THIS DOCUMENT.

PRODUCT WARRANTY PERIOD

Table with 3 columns: Product Type, Parts, Labor. Row: Car Stereo Products, 1 Year, 1 Year.

The warranty period for retail customers who rent the product commences upon the date product is first put into use (a) during the rental period or (b) retail sale, whichever occurs first.

WHAT IS NOT COVERED

IF THIS PRODUCT WAS PURCHASED FROM AN UNAUTHORIZED DISTRIBUTOR, THERE ARE NO WARRANTIES, EXPRESS OR IMPLIED, INCLUDING THE IMPLIED WARRANTY OF MERCHANTABILITY AND THE IMPLIED WARRANTY OF FITNESS FOR A PARTICULAR PURPOSE AND THIS PRODUCT IS SOLD STRICTLY "AS IS" AND "WITH ALL FAULTS".

PIONEER SHALL NOT BE LIABLE FOR ANY CONSEQUENTIAL AND/OR INCIDENTAL DAMAGES.

PIONEER DOES NOT WARRANT ANY PRODUCT LISTED ABOVE WHEN IT IS USED IN A TRADE OR BUSINESS OR IN ANY INDUSTRIAL OR COMMERCIAL APPLICATION.

THIS WARRANTY DOES NOT APPLY IF THE PRODUCT HAS BEEN SUBJECTED TO POWER IN EXCESS OF ITS PUBLISHED POWER RATING.

THIS WARRANTY DOES NOT COVER DISPLAY SCREENS DAMAGED BY STATIC, NON-MOVING, IMAGES APPLIED FOR LENGTHY PERIODS (BURN-IN).

THIS WARRANTY DOES NOT COVER THE CABINET OR ANY APPEARANCE ITEM, USER ATTACHED ANTENNA, ANY DAMAGE TO RECORDS OR RECORDING TAPES OR DISCS, ANY DAMAGE TO THE PRODUCT RESULTING FROM ALTERATIONS, MODIFICATIONS NOT AUTHORIZED IN WRITING BY PIONEER, ACCIDENT, MISUSE OR ABUSE, DAMAGE DUE TO LIGHTNING OR TO POWER SURGES, SUBSEQUENT DAMAGE FROM LEAKING, DAMAGE FROM INOPERATIVE BATTERIES, OR THE USE OF BATTERIES NOT CONFORMING TO THOSE SPECIFIED IN THE OWNER'S MANUAL.

THIS WARRANTY DOES NOT COVER THE COST OF PARTS OR LABOR WHICH WOULD BE OTHERWISE PROVIDED WITHOUT CHARGE UNDER THIS WARRANTY OBTAINED FROM ANY SOURCE OTHER THAN A PIONEER AUTHORIZED SERVICE COMPANY OR OTHER DESIGNATED LOCATION. THIS WARRANTY DOES NOT COVER DEFECTS OR DAMAGE CAUSED BY THE USE OF UNAUTHORIZED PARTS OR LABOR OR FROM IMPROPER MAINTENANCE.

ALTERED, DEFACED, OR REMOVED SERIAL NUMBERS VOID THIS ENTIRE WARRANTY

NO OTHER WARRANTIES

IN THE U.S.A. - PIONEER LIMITS ITS OBLIGATIONS UNDER ANY IMPLIED WARRANTIES INCLUDING, BUT NOT LIMITED TO, THE IMPLIED WARRANTIES OF MERCHANTABILITY AND FITNESS FOR A PARTICULAR PURPOSE, TO A PERIOD NOT TO EXCEED THE WARRANTY PERIOD. NO WARRANTIES SHALL APPLY AFTER THE WARRANTY PERIOD. SOME STATES DO NOT ALLOW LIMITATIONS ON HOW LONG AN IMPLIED WARRANTY LASTS AND SOME STATES DO NOT ALLOW THE EXCLUSIONS OR LIMITATIONS OF INCIDENTAL OR CONSEQUENTIAL DAMAGES, SO THE ABOVE LIMITATIONS OR EXCLUSIONS MAY NOT APPLY TO YOU.

IN CANADA - EXCEPT AS EXPRESSLY PROVIDED HEREIN, THERE ARE NO REPRESENTATIONS, WARRANTIES, OBLIGATIONS OR CONDITIONS, IMPLIED, STATUTORY OR OTHERWISE, APPLICABLE TO THIS PRODUCT.

TO OBTAIN SERVICE (EXCEPT CAR SPEAKERS SOLD IN THE U.S.A. ONLY)

PUSA and POC have appointed a number of Authorized Service Companies throughout the U.S.A. and Canada should your product require service. To receive warranty service you need to present your sales receipt or, if rented, your rental contract showing place and date of original owner's transaction.

TO OBTAIN SERVICE ON CAR SPEAKERS SOLD IN THE U.S.A.

Should your car speaker require service please return it to your retail dealer for exchange. To receive warranty service you will need to present your sales receipt showing place and date of original owner's retail purchase.

On all complaints and concerns in the U.S.A. call Customer Support at 1-800-421-1404, or, in Canada, call Customer Satisfaction at (905) 479-4411.

IN THE U.S.A.

For hook-up and operation of your unit or to locate an Authorized Service Company, please call or write:

CUSTOMER SUPPORT DIVISION
PIONEER ELECTRONICS (USA) INC.
P.O. BOX 1760
LONG BEACH, CALIFORNIA 90801
1-800-421-1404

http://www.pioneerelectronics.com

IN CANADA

For additional information on this warranty, please call or write:

CUSTOMER SATISFACTION GROUP
PIONEER ELECTRONICS OF CANADA, INC.
300 ALLSTATE PARKWAY
MARKHAM, ON L3R 0P2
(905) 479-4411
1-877-283-5901

http://www.pioneerelectronics.com

DISPUTE RESOLUTION

IN THE U.S.A. - Following our response to any initial request to Customer Support, should a dispute arise between you and Pioneer, Pioneer makes available its Complaint Resolution Program to resolve the dispute. The Complaint Resolution Program is available to you without charge.

To use the Complaint Resolution Program call 1-800-421-1404 and explain to the customer service representative the problem you are experiencing, steps you have taken to have the product repaired during the warranty period and the name of the authorized Distributor/Dealer from whom the Pioneer product was purchased.

IN CANADA - Call the Customer Satisfaction Manager at (905) 946-7446 to discuss your complaint and to obtain a prompt resolution.

RECORD THE PLACE AND DATE OF PURCHASE FOR FUTURE REFERENCE

Model No. Serial No. Purchase Date

Purchased From

KEEP THIS INFORMATION AND YOUR SALES RECEIPT IN A SAFE PLACE

< ARY1048-E/U >

Printed in China